

# CASCADE™

# TEK

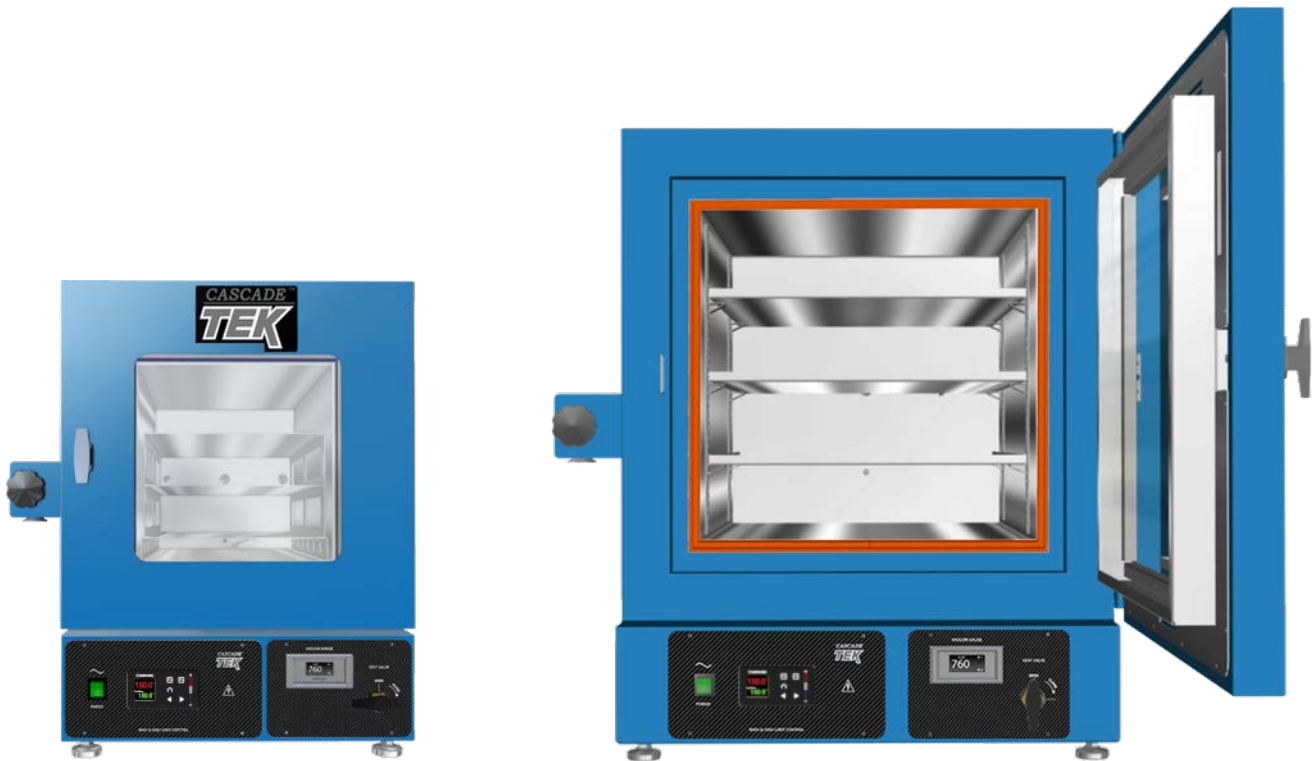

Vacuum Ovens TVO-2-SV TVO-2-2-SV TVO-5-SV TVO-5-2-SV  
Installation and Operation Manual

The **TVO-2-SV** and **TVO-5-SV** ovens require a 110 – 120-volt power outlet.

THIS UNIT REQUIRES A DEDICATED 15-20 amp CIRCUIT

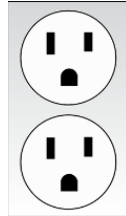

Standard NEMA 5-15R wall socket

The **TVO-2-2-SV** and **TVO-5-2-SV** ovens require a 220 – 240 volt power outlet.

THIS UNIT REQUIRES A DEDICATED 15-20 amp CIRCUIT

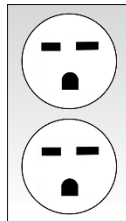

Standard NEMA 6-15R wall socket

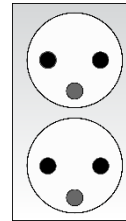

Standard CEE7/7 wall socket



**Warning:** This product contains chemicals, including triglycidyl isocyanurate, known to the State of California to cause cancer as well as birth defects or other reproductive harm. For more information, go to [www.P65Warnings.ca.gov](http://www.P65Warnings.ca.gov).



**¡Advertencia!** Este producto contiene sustancias químicas, incluido el triglicidil isocianurato, que el estado de California sabe que causa cáncer, así como defectos de nacimiento u otros daños reproductivos. Para obtener más información, visite [www.P65Warnings.ca.gov](http://www.P65Warnings.ca.gov).



**Avertissement!** Ce produit peut vous exposer à des produits chimiques, dont l'isocyanurate de triglycidyle, reconnu par l'État de Californie pour provoquer le cancer, des anomalies congénitales ou d'autres problèmes de reproduction. Pour plus d'informations, visitez le site [www.P65Warnings.ca.gov](http://www.P65Warnings.ca.gov).

# Vacuum Ovens

**TVO-2-SV, TVO-5-SV: 110 – 120 Voltage**

**TVO-2-2-SV, TVO-5-2-SV: 220 – 240 Voltage**

**Part Number (Manual): 4861890**

**Revision: September 2, 2025**

Cascade TEK Part ID Numbers:

Model	TVO-2-SV	TVO-2-2-SV	TVO-5-SV	TVO-5-2-SV
Part ID	CTVS224	CTVS224-EA	CTVS524	CTVS524-EA

The Part ID denotes the specific build version of the model.

Cascade TEK brand of products is made by Sheldon Manufacturing, Inc. Sheldon Manufacturing Inc. is an ISO 9001 certified manufacturer.



## Safety Certifications

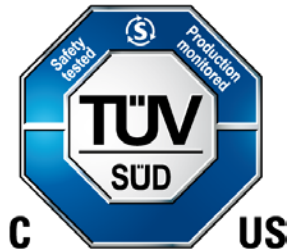

These units are CUE listed by TÜV SÜD as vacuum ovens for professional, industrial or educational use where the preparation or testing of materials is done at an ambient air pressure range of 22.14 – 31.3 inHg (75 – 106 kPa), and no flammable, volatile or combustible materials are being heated.

These units have been tested to the following requirements:

CAN/CSA C22.2 No. 61010-1:2012

CAN/CSA C22.2 No. 61010-2-010:2015

UL 61010-1:2012

UL 61010-2-010:2015

EN 61010-1:2010

EN 61010-2-010:2014

# TABLE OF CONTENTS

<i>Read this Manual</i> .....	6
<i>Safety Considerations and Requirements</i> .....	6
<i>Contacting Assistance</i> .....	7
<i>Manufacturing Warranty</i> .....	7
<i>Engineering Improvements</i> .....	7
<i>Vacuum Supply Requirements</i> .....	8
<i>Oven Chamber Gaskets</i> .....	9
<b>RECEIVING YOUR OVEN</b> .....	<b>10</b>
<i>Inspect the Shipment</i> .....	10
<i>Orientation Images</i> .....	11
<i>Dimension Visuals</i> .....	15
<i>Record the Data Plate Information</i> .....	17
<b>INSTALLATION</b> .....	<b>18</b>
<i>Installation Procedures Checklist</i> .....	18
<i>Required Ambient Conditions</i> .....	19
<i>Required Clearances</i> .....	19
<i>Power Source Requirements 110 – 120 Volts</i> .....	20
<i>Power Source Requirements 220 – 240 Volts</i> .....	22
<i>Lifting and Handling</i> .....	24
<i>Leveling</i> .....	24
<i>Install the Oven</i> .....	25
<i>Installation Cleaning</i> .....	25
<i>Shelving Installation</i> .....	26
<i>Connect to the Vacuum Supply</i> .....	28
<i>Connect to a Gas Backfill Supply</i> .....	29
<b>GRAPHIC SYMBOLS</b> .....	<b>30</b>
<b>CONTROL OVERVIEW</b> .....	<b>31</b>
<b>OPERATION</b> .....	<b>33</b>
<i>Operating Precautions</i> .....	33
<i>Theory of Operation</i> .....	34
<i>Put the Oven into Operation</i> .....	36
<i>Set the High Temperature Limit</i> .....	38
<i>Evacuating and Backfilling the Oven Chamber</i> .....	39
<i>Setting the Constant Temperature Setpoint</i> .....	40
<i>Temperature Programs</i> .....	40
<i>High Temperature Limit Activated</i> .....	41
<i>Changing the Unit of Measurement</i> .....	42
<i>Data Ports</i> .....	43
<i>Oven Cooldowns</i> .....	43
<b>OPERATOR MAINTENANCE</b> .....	<b>44</b>
<i>Cleaning</i> .....	44
<i>Maintaining Atmospheric Integrity</i> .....	45
<i>Electrical Components</i> .....	45
<i>Vacuum Pump Maintenance</i> .....	45
<i>Storage</i> .....	45
<i>Heating Issues – Diagnostic Questionnaire</i> .....	46
<i>Vacuum Leak Issues – Diagnostic Questionnaire</i> .....	51
<b>UNIT SPECIFICATIONS</b> .....	<b>57</b>
<i>Weight</i> .....	57

*Dimensions* ..... 57  
*Capacity*..... 57  
*Shelf Capacity by Weight* ..... 57  
*Vacuum* ..... 58  
*Temperature*..... 58  
*Power*..... 58  
**PARTS LIST**..... **59**  
*Replacement Gaskets* ..... 60

# INTRODUCTION

*Thank you for purchasing a Cascade TEK oven. We know you have many choices in today's competitive marketplace when it comes to constant temperature equipment. We appreciate you choosing ours. We stand behind our products and will be here if you need us.*

## ***READ THIS MANUAL***

Failure to follow the guidelines and instructions in this operation manual may create a protection impairment by disabling or interfering with the unit safety features. This can result in injury or death.

Before using the unit, read the manual in its entirety to understand how to install, operate, and maintain the unit in a safe manner. Ensure all operators are given appropriate training before the unit begins service. Keep this manual available for use by all operators.

## ***SAFETY CONSIDERATIONS AND REQUIREMENTS***

Follow basic safety precautions, including all national laws, regulations, and local ordinances in your area regarding the use of this unit. If you have any questions about local requirements, please contact the appropriate agencies.

### **SOPs**

Because of the range of potential applications this unit can be used for, the operator or their supervisors must draw up a site-specific standard operating procedure (SOP) covering each application and associated safety guidelines. This SOP must be written and available to all operators in a language they understand.

### **Intended Applications and Locations**

TVO vacuum ovens are engineered for constant temperature drying, curing, and baking applications under vacuum in professional, industrial, and educational environments. The ovens are not intended for use at hazardous or household locations.

### **Power**

Your unit and its recommended accessories are designed and tested to meet strict safety requirements.

- Use a dedicated 15-20 amp circuit.
- The unit is designed to connect to a power source using the specific power cord type shipped with the unit.
- Always plug the unit power cord into a protective earth grounded electrical outlet conforming to national and local electrical codes. If the unit is not grounded properly, parts such as knobs and controls can conduct electricity and cause serious injury. Use a dedicated 15-20 amp circuit.
- Do not bend the power cord excessively, step on it, or place heavy objects on it.
- A damaged cord can be a shock or fire hazard. Never use a power cord if it is damaged or altered in any way.
- Use only approved accessories. Do not modify system components. Any alterations or modifications to your unit not explicitly authorized by the manufacturer can be dangerous and will void your warranty.

# INTRODUCTION

## *CONTACTING ASSISTANCE*

Phone hours for Customer Support are 6 am – 4:30 pm Pacific Coast Time (west coast of the United States, UTC -8), Monday – Friday. Please have the following information ready when calling or emailing Customer Support: the **model number**, **serial number**, **part number**, and **part ID** (see page 17).

support@cascadetek.com  
1-800-322-4897  
503-640-3000

### **Manufacturing and Customer Support**

Cascade TEK  
by Sheldon Manufacturing, Inc.  
300 N. 26<sup>th</sup> Ave.  
Cornelius, OR 97113  
USA

## *MANUFACTURING WARRANTY*

For information on your warranty and online warranty registration please visit: <https://www.cascadetek.com/warranty/>

## *ENGINEERING IMPROVEMENTS*

Cascade TEK continually improves all of its products. As a result, engineering changes and improvements are made from time to time. Therefore, some changes, modifications, and improvements may not be covered in this manual. If your unit's operating characteristics or appearance differs from those described in this manual, please contact your Cascade TEK dealer or customer service representative for assistance.

# INTRODUCTION

## VACUUM SUPPLY REQUIREMENTS

### Pump or Building System Required

The oven does not come with a vacuum pump. **A pump must be separately purchased for the oven.**

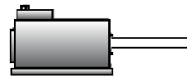

Vacuum Pump

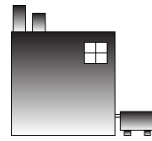

Building Vacuum Supply

### Required Flow Rate

For the chamber to seal, the vacuum pump or system must be able to evacuate at least 1 cubic foot per minute (cfm) for each cubic foot of oven chamber volume (CuFt).

Model	Chamber Capacity	Min. Pump Capacity CFM	Min. Pump Capacity LPM
TVO-2-SVs	1.67 CuFt	2 cfm	57 Liters per Minute
TVO-5-SVs	4.50 CuFt	5 cfm	142 Liters per Minute

The use of clamps to secure vacuum tubing is recommended.

### Minimum Evacuation Level

The oven must be evacuated to **500 torr or lower** for the oven chamber door to seal. The manufacturer recommends pumping down below 500 torr as part of the first step in a baking recipe to ensure a good seal. This helps safeguard the oven and pump.

### Pump Type Selection

Consult a vacuum pump specialist to determine the pump type best suited to your baking application. The correct selection of a vacuum pump is critical for evacuating the chamber to the level required for your vacuum baking applications in a timely manner. The nature of the sample or product being heated should drive the selection of the pump, including the types of chemicals outgassed during the baking process. Common pump types include Chemical Duty PTFE Dry, Standard Duty Dry, and Compact Direct-Drive. The selection of an application-specific pump can improve the overall oven performance and minimize pump maintenance costs. **All maintenance and instructional information should be obtained from the pump manufacturer** if not shipped with the pump.

### Oil Trap Recommended

The use of an oil trap plumbed on the vacuum line between the oven and the pump is strongly recommended. The trap protects the pump from any oils outgassed during your baking procedure. This extends the life of the pump.

# INTRODUCTION

## *OVEN CHAMBER GASKETS*

### **Wear and Replacement**

Chamber liner gaskets are non-warranty, high-wear consumable items subject to compression forces, heat, and outgassed byproducts. Heavy usage rates may necessitate frequent replacements. The manufacturer strongly recommends **keeping a spare gasket on hand** during operation.

### **Included Chamber Gasket**

Each oven comes with a replaceable silicone gasket installed on the chamber liner which seals the oven chamber when the door is closed and the chamber is under vacuum. The gasket must be replaced periodically and is rated to 230°C. It is vulnerable to acids and solvents. The manufacturer also offers for sale *Viton®*, fluorosilicone, and Buna-N gaskets. See page 60 for information on gasket type suitability for baking applications.

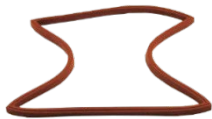

### **Do Not Use Vacuum Grease**

- These ovens do not require vacuum grease to seal.
- The use of grease may contaminate the chamber and samples and can foul vacuum pumps.
- **Silicone vacuum grease will damage silicone gaskets.** Do not use silicone grease with silicone gaskets.

# RECEIVING YOUR OVEN

## *INSPECT THE SHIPMENT*

When a unit leaves the factory, safe delivery becomes the responsibility of the carrier. **Damage sustained during transit is not covered by the manufacturing defect warranty.** When you receive your unit, inspect it for concealed loss or damage to its interior and exterior. If you find any damage to the unit, **follow the carrier's procedure for claiming damage or loss.**

Save the shipping carton until you are certain that the unit and its accessories function properly.

1. Carefully inspect the shipping carton for damage.
2. Report any damage to the carrier service that delivered the unit.
3. If the carton is not damaged, open the carton and remove the contents.
4. Inspect the unit for signs of damage. See the orientation depictions on the next pages as a reference.
5. The unit should come with an Installation and Operation Manual and a Temperature Program Manual.
6. Verify the correct number of accessories has been included.
7. Carefully check all packaging for accessories before discarding.

Included Accessories:

TVO-2-SVs	Tall Shelves	Short Bottom Shelf	Leveling Feet
	2	1	4

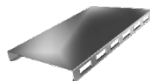

TVO-5-SVs	Shelves	Shelf Clips	Leveling Feet
	3	12	4

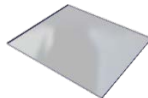

## Power Cords

Model	NEMA 5-15P 125 Volt	NEMA 6-15P 240 Volt (US)	CEE 7/7 250 Volt (Euro)
TVO-2-SV	1	0	0
TVO-5-SV	1	0	0
TVO-2-2-SV	0	1	1
TVO-5-2-SV	0	1	1



# RECEIVING

## ORIENTATION IMAGES

TVO-5-SV and TVO-5-2-SV



Side-Mounted  
Vacuum Hand Valve

**Back of Units:** See next page.

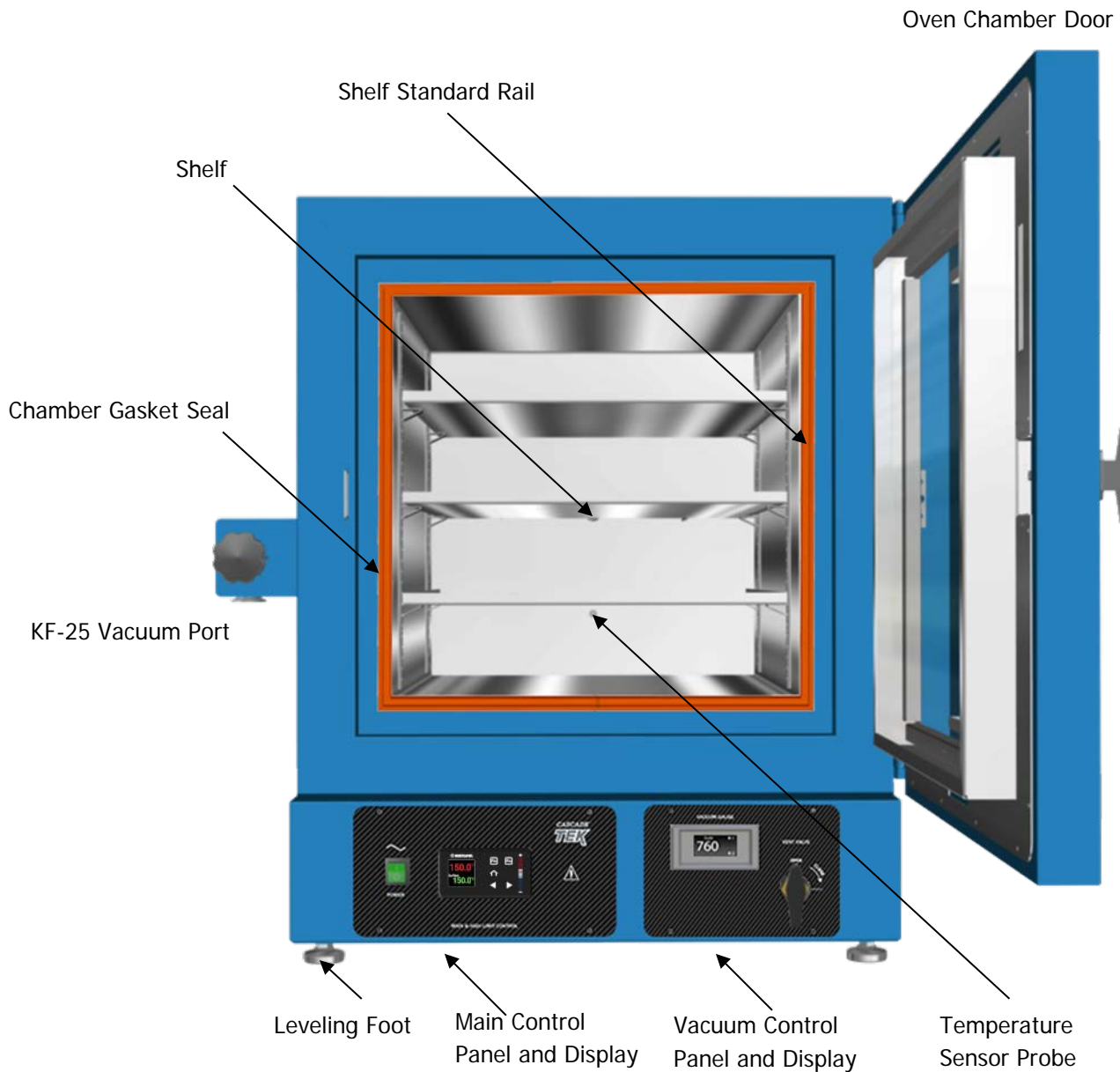

# RECEIVING

Back of TVO-5-SV and TVO-5-2-SV

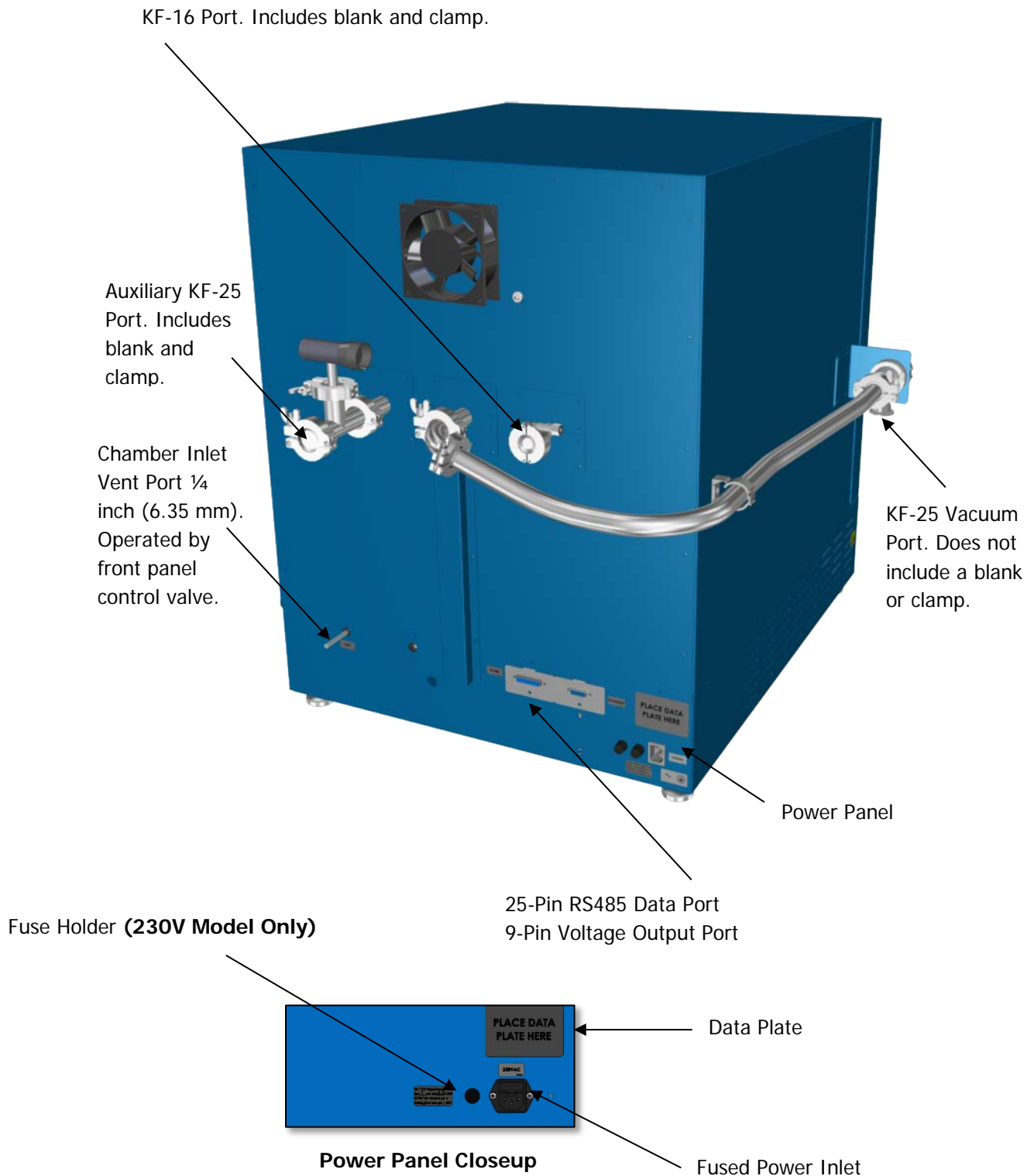

# RECEIVING

## TVO-2-SV and TVO-2-2-SV

Side-Mounted Manual Vacuum Hand Valve



**Back of Units:** See next page.

Oven Chamber Door

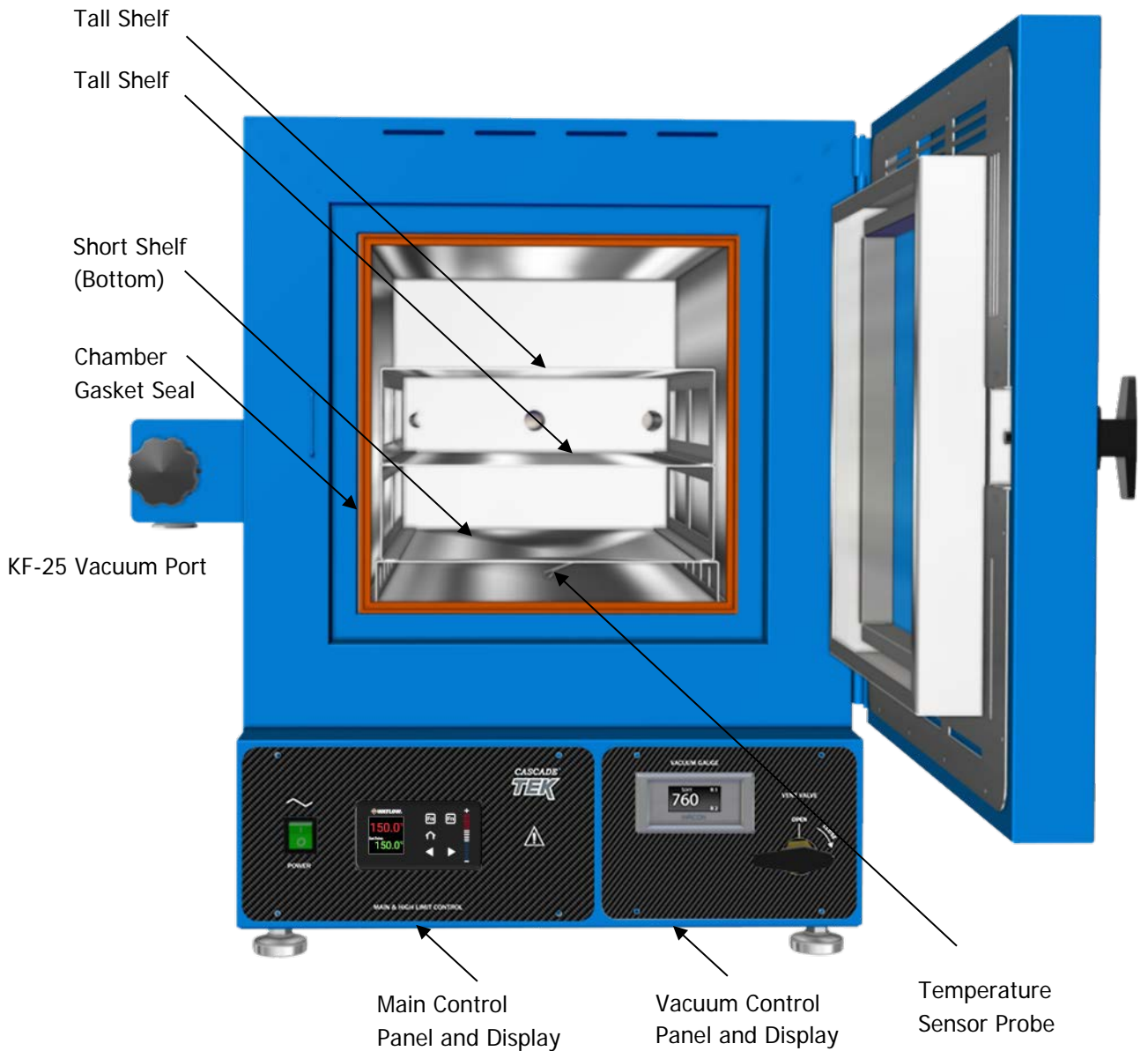

# RECEIVING

## Back of TVO-2-SV and TVO-2-2-SV

KF-16 Port. Includes blank and clamp.

Auxiliary KF-25 Port. Includes KF-25 blank and clamp.

Chamber Vent Inlet Port ¼ inch (6.35 mm). Operated by front panel control valve.

KF-25 Vacuum Port. Does not include a blank or clamp.

25-Pin RS485 Data Port  
9-Pin Voltage Output Port

Power Panel

Fuse Holder (230V Unit Only)

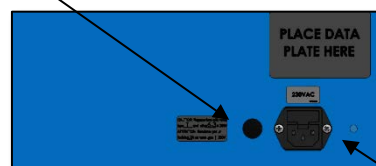

Data Plate

Power Panel Closeup

Fused Power Inlet

# RECEIVING

## *DIMENSION VISUALS*

### **TVO-5-SVs**

See page 19 for the required ventilation clearances.

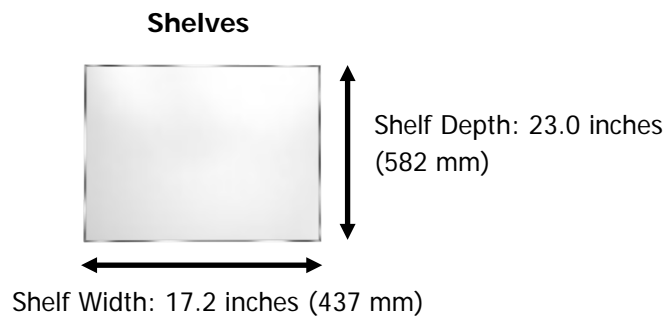
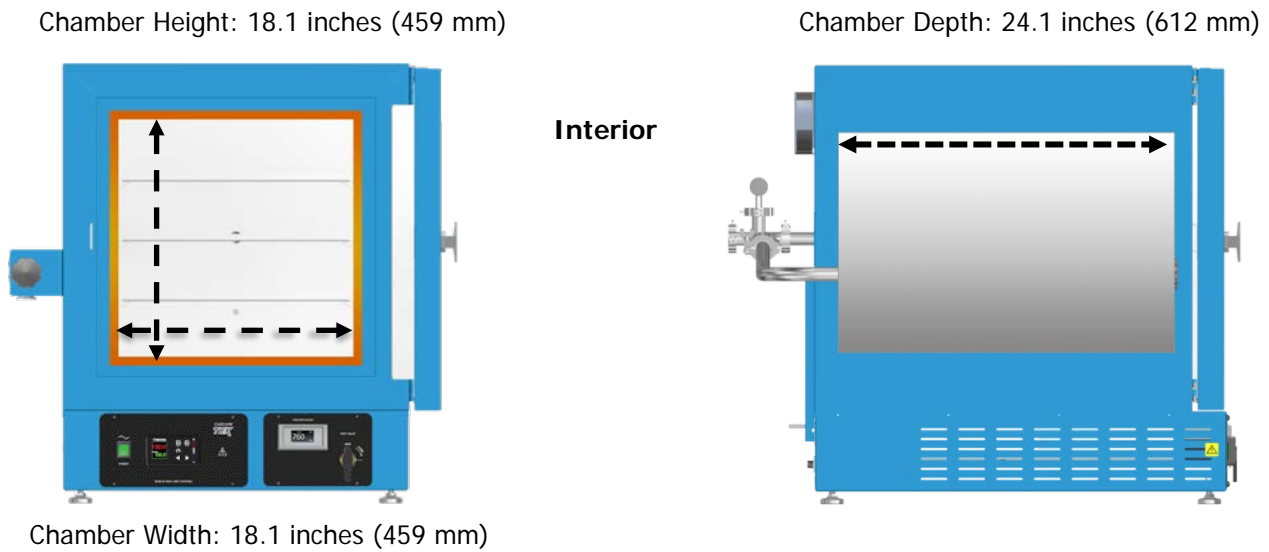
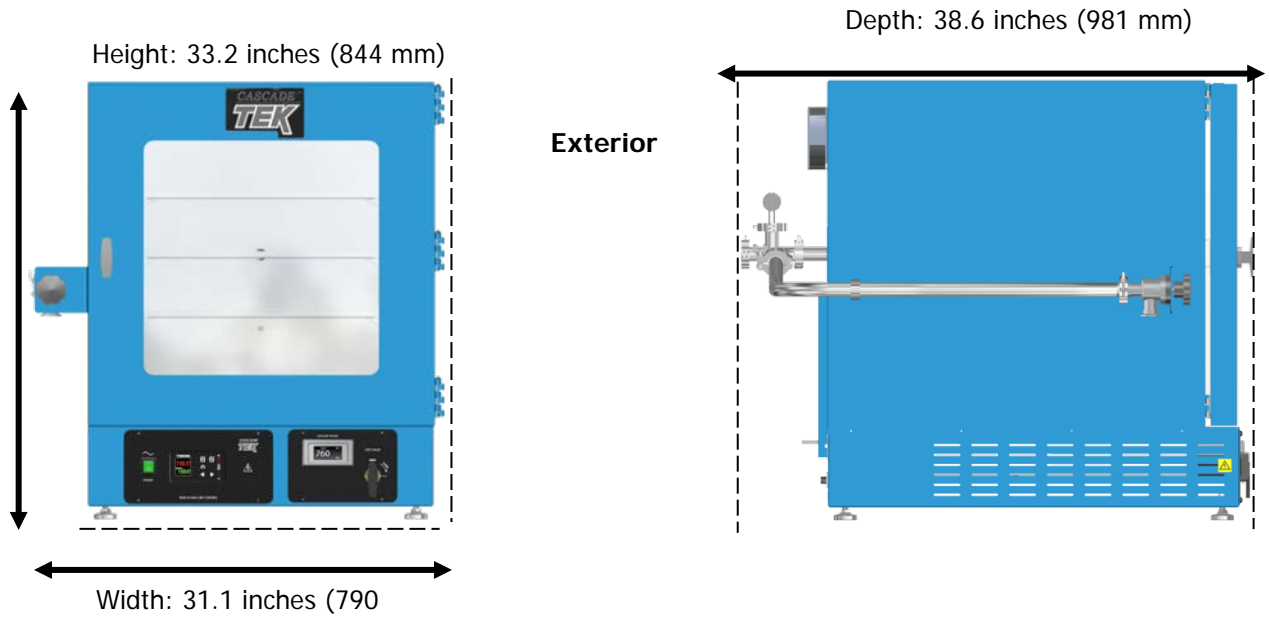

# RECEIVING

## TVO-2-SVs

See page 19 for the required ventilation clearances.

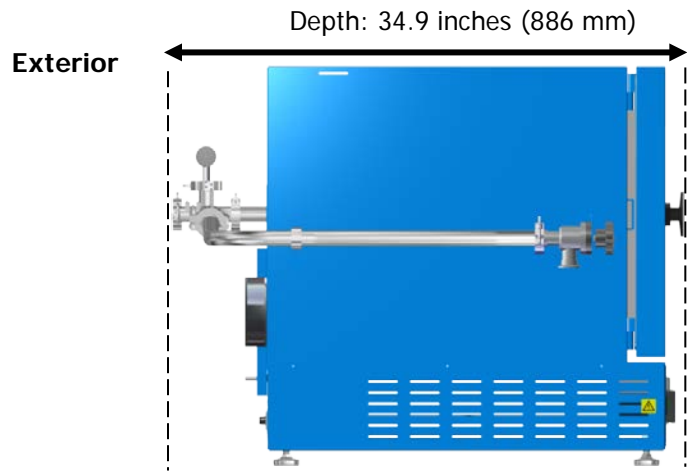
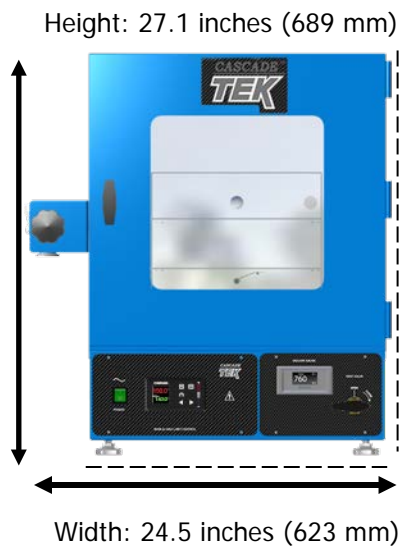

Chamber Height: 12.0 inches (304 mm)

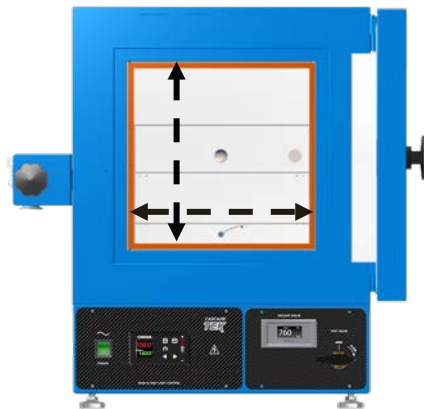

Chamber Width: 12.0 inches (304 mm)

Chamber Depth: 20.0 inches (508 mm)

Interior

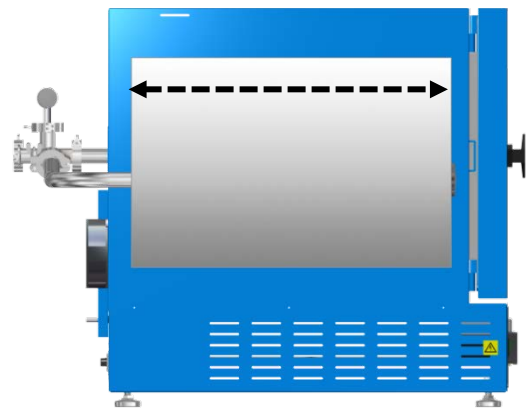

Tall Shelves



Shelf Depth: 19.0 inches (483 mm)

Shelf Width: 11.3 inches (223 mm)

## *RECORD THE DATA PLATE INFORMATION*

The data plate contains the unit **model number**, **serial number**, **part number**, and **part ID**. Customer Support will need this information during any support call. Record it below for future reference.

- The data plate is located on the back of the oven above the power inlet.

MODEL NO:	
SERIAL NO:	
PART NO:	
PART ID:	

## *INSTALLATION PROCEDURES CHECKLIST*

For installing the oven in a new workspace location.

### **Pre-Installation**

- ✓ Verify a vacuum supply source suitable for your application is available and can be connected to the oven, page 8.
  - See page 28 for the oven gas and vacuum port locations.
- ✓ Check that the required ambient conditions for the unit are met, page 19.
- ✓ Check that the spacing clearance requirements are met, page 19.
  - Unit dimensions may be found on page 57.
- ✓ Check that a suitable electrical outlet and power supply is present, page 20.

### **Install the oven in a suitable workspace location**

- ✓ Review the lifting and handling instructions, page 24.
- ✓ Install the unit leveling feet, page 24.
- ✓ Install the oven in its workspace location, page 25.

### **Set up the oven for use**

- ✓ Clean the oven shelving. Clean the chamber if needed, page 25.
- ✓ Install the shelving in the oven chamber, page 26.
- ✓ Connect the oven to its vacuum supply source along with any optional backfill gas supply, page 29.

# INSTALLATION

## REQUIRED AMBIENT CONDITIONS

This oven is built for use indoors at room temperatures between **15°C and 40°C (59°F and 104°F)**, at no greater than **80% Relative Humidity** (at 25°C / 77°F). The ambient temperature should not change by 2°C (3.6°F) or more during operation.

The maximum altitude is 2,000 feet or 610 meters. The pollution degree of the intended environment is 2. Operating outside these conditions may adversely affect the oven temperature performance.

When selecting a location to install the unit, consider all environmental conditions that can impact its temperature performance. These include:

- Proximity to other ovens, autoclaves, and any device that produces significant radiant heat
- Heating and cooling vents or other sources of fast-moving air currents
- High-traffic areas
- Direct sunlight

## REQUIRED CLEARANCES

These clearances are required to provide air flows for ventilation and cooling.

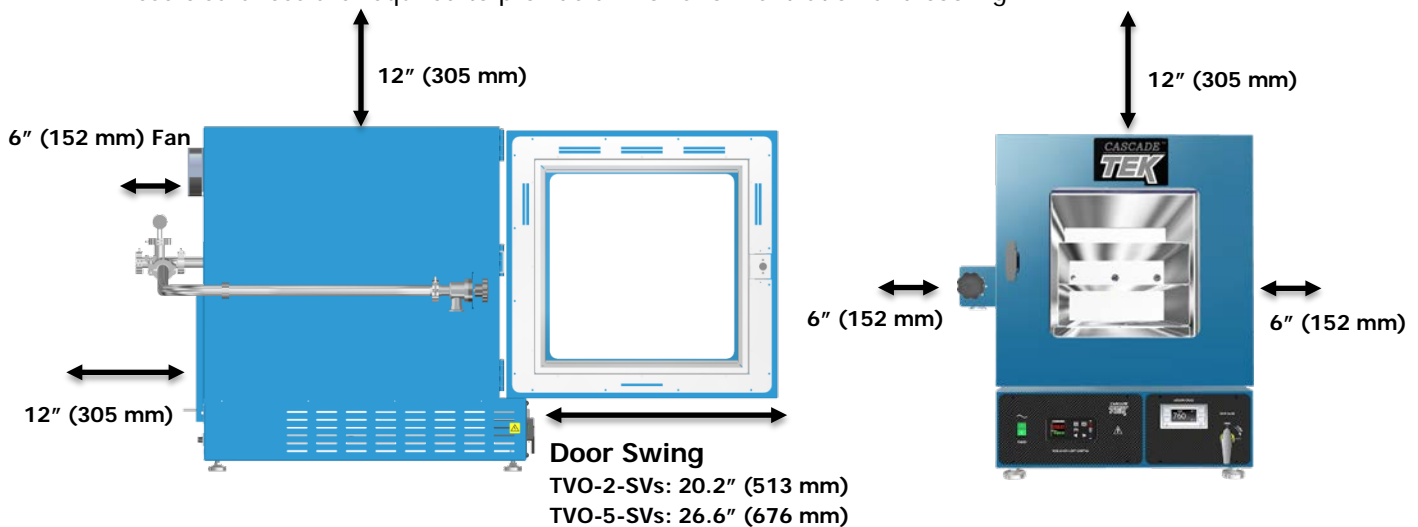

**6 inches (152 mm)** of clearance is required on the sides.

**6 inches (152 mm)** of clearance is required from the side-mounted vacuum valve on the left side of the unit. The vacuum tube along the left side of the oven may grow hot during operation.

**12 inches (305 mm)** of headspace clearance is required between the top of the unit and any overhead partitions and on the back of the oven.

Do not place objects on top of the oven.

KF-25 and KF-16 vacuum ports are located on the back of the oven for venting and introducing a vacuum-rated thermocouple feedthrough into the chamber. A KF-25 vacuum port is located on the side of the oven for connecting to vacuum supply. Leave sufficient clearance for operators to safely access these ports.

# INSTALLATION

## POWER SOURCE REQUIREMENTS 110 – 120 VOLTS

### TVO-2-SV TVO-5-SV

When selecting a location for the unit, verify each of the following requirements is satisfied.

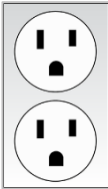

**Power Source:** The wall power outlet must meet the power requirements listed on the unit data plate. **This unit requires a dedicated 15-20 amp circuit.**

Model	AC Voltage	Amperage	Frequency
TVO-2-SV	110 – 120	10.0	50/60 Hz
TVO-5-SV	110 – 120	13.0	50/60 Hz

- Wall power sources must be protective earth grounded and **single phase**.
- Wall power sources must conform to all national and local electrical codes.
- **Supplied voltage must not vary more than 10% from the data plate rating.** Damage to the unit may result if the supplied voltage varies more than 10%.
- **The recommended wall circuit breakers for these units are 15 amps.**
- Use a dedicated 15-20 amp circuit to prevent loss of product due to overloading or circuit failure. The circuit must match or exceed the amperage requirement listed on the unit data plate.



### Power Cord

The unit must be positioned so that all operators can quickly unplug the oven in the event of an emergency.

- The unit comes provided with a **125 volt, 15 amp, 9ft 5 in (2.86m) NEMA 5-15P** power cord.

# INSTALLATION

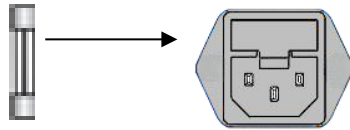

## Fuse

Each unit ships with one fuse installed in the power inlet.

- The fuse must be installed and intact for the unit to operate.
- Always find and fix the cause of a blown fuse prior to putting the unit back into operation.
- Fuse type:
  - T16A, 250V 5x20mm

## Power

Your unit and its recommended accessories are designed and tested to meet strict safety requirements.

- This unit requires a dedicated 15-20 amp circuit.
- The unit is designed to connect to a power source using the specific power cord type shipped with the unit.
- Always plug the unit power cord into a protective earth grounded electrical outlet conforming to national and local electrical codes. If the unit is not grounded properly, parts such as knobs and controls can conduct electricity and cause serious injury.
- Do not bend the power cord excessively, step on it, or place heavy objects on it.
- A damaged cord can be a shock or fire hazard. Never use a power cord if it is damaged or altered in any way.
- **Use only approved accessories.** Do not modify system components. Any alterations or modifications to your unit not explicitly authorized by the manufacturer can be dangerous and will void your warranty.

# INSTALLATION

## POWER SOURCE REQUIREMENTS 220 – 240 VOLTS

### TVO-2-2-SV TVO-5-2-SV

When selecting a location for the unit, verify each of the following requirements is satisfied.

**Power Source:** The wall power outlet must meet the power requirements listed on the unit data plate. **This unit requires a dedicated 15-20 amp circuit.**

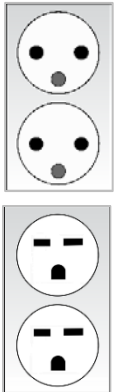

Model	AC Voltage	Amperage	Frequency
TVO-2-2-SV	220 – 240	5.5	50/60 Hz
TVO-5-2-SV	220 – 240	7.0	50/60 Hz

- Wall power sources must be protective earth grounded and **single phase**.
- Wall power sources must conform to all national and local electrical codes.
- **Supplied voltage must not vary more than 10% from the data plate rating.** Damage to the unit may result if the supplied voltage varies more than 10%.
- **The recommended wall circuit breakers for these units are a dedicated 15- 20 amp circuits.**
- Use a dedicated 15-20 amp circuit to prevent loss of product due to overloading or circuit failure. The circuit must match or exceed the amperage requirement listed on the unit data plate.

### Power Cord



The unit must be positioned so that all operators can quickly unplug the oven in the event of an emergency.

- The unit comes provided with **250 volt, 10 amp, 8ft 2in (2.5m), CEE 7/7** power cord.
- The unit comes provided with a **240 volt, 15 amp, 8ft 2in (2.5m) NEMA 6-15P** power cord.



## Fuses

Each unit ships with one fuse installed in the fuse holder and a second fuse installed in the adjacent power inlet.

- Both fuses must be installed and intact for the unit to operate.
- Always find and fix the cause of a blown fuse prior to putting the unit back into operation.
- Fuse types:
  - T6.3A 250V 5x20mm (TVO-2-2-SV)
  - T10A 250V 5x20mm (TVO-5-2-SV)

## Power

Your unit and its recommended accessories are designed and tested to meet strict safety requirements.

- This unit requires a dedicated 15-20 amp circuit.
- The unit is designed to connect to a power source using the specific power cord type shipped with the unit.
- Always plug the unit power cord into a protective earth grounded electrical outlet conforming to national and local electrical codes. If the unit is not grounded properly, parts such as knobs and controls can conduct electricity and cause serious injury.
- Do not bend the power cord excessively, step on it, or place heavy objects on it.
- A damaged cord can be a shock or fire hazard. Never use a power cord if it is damaged or altered in any way.
- **Use only approved accessories.** Do not modify system components. Any alterations or modifications to your unit not explicitly authorized by the manufacturer can be dangerous and will void your warranty.

# INSTALLATION

## *LIFTING AND HANDLING*

The oven is heavy. Use appropriate lifting devices that are sufficiently rated for these loads. Follow these guidelines when lifting the oven:

- Lift the oven only from its bottom surface.
- Doors, handles, and knobs are not adequate for lifting or stabilization.
- Restrain the oven completely while lifting or transporting so it cannot tip.
- Remove all removable parts, such as shelves and trays, and lock doors in the closed position during transfers to prevent shifting and damage.

## *LEVELING*

The unit must be level and stable for safe operation.

Install the 4 leveling feet in the 4 corner holes in the bottom of the oven.

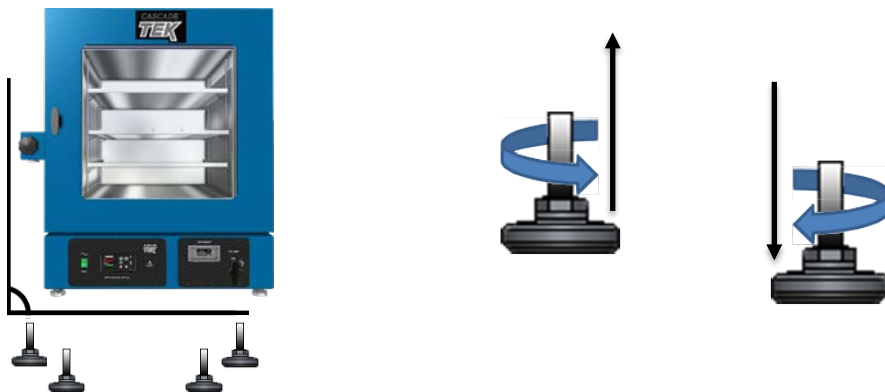

---

**Note:** To prevent damage when moving the unit, turn all 4 leveling feet so that the leg of each foot sits inside the unit.

---

# INSTALLATION

## *INSTALL THE OVEN*

Install the unit in a workspace location that meets the criteria discussed in the previous entries of the Installation section.

- Do not connect the oven to its power source at this time.

## *INSTALLATION CLEANING*

The manufacturer recommends cleaning the shelving and oven chamber prior to installation of the shelving in the chamber. The unit was cleaned at the factory but may have been exposed to contaminants during shipping.

- Remove all wrappings and coverings from shelving prior to cleaning and installation.
- See the **Cleaning** topic in the Operator Maintenance section (see page 44) for more information on how to clean the oven chamber and shelving.
- **Do not clean with deionized water.**

# INSTALLATION

## *SHELVING INSTALLATION*

Heating in a vacuum environment takes place primarily through conduction. Heat flows from oven elements inside the chamber walls and floor to the shelves. Install the shelves as described below to ensure proper heat conduction and temperature measurement.

Never place samples or product on the oven chamber floor. The floor runs hotter than the shelf temperatures. All oven heating specifications are for shelving temperatures only.

TVO-2-SVs

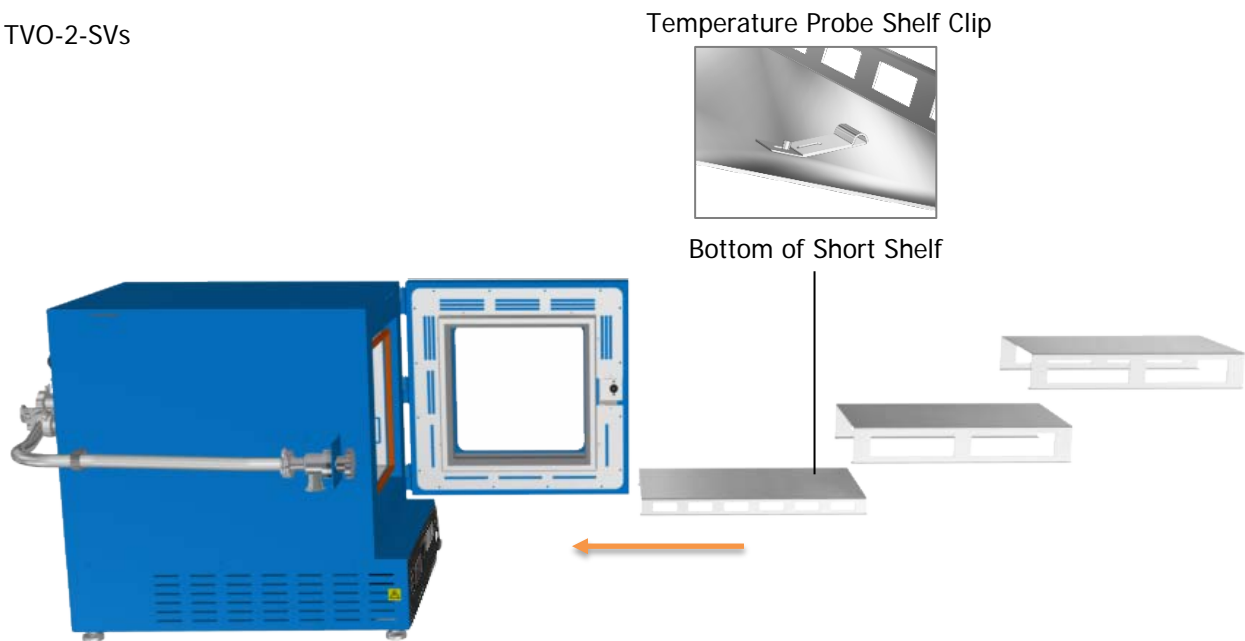

1. Carefully slide the short shelf into position on the chamber floor, sliding the clip on the bottom of the shelf onto the oven temperature probe.

- The shelf clip should be on the side of the shelf closest to the oven door. This ensures the best measurement position for the probe.
- The oven probe extends from the back wall near the floor of the chamber.
- **The short shelf must be on the bottom** of the shelf-stack to ensure the oven accurately measures and controls the shelving temperature.

2. Place the 2 tall shelves on top of the short shelf.

**Continued next page**

# INSTALLATION

## Shelving Installation Continued

### TVO-5-SVs Shelving

To ensure accurate temperature measurement, **one shelf bottom must be in close proximity to the oven temperature probe**. This probe extends out from the chamber back wall. Do not place the shelf in direct contact with the probe.

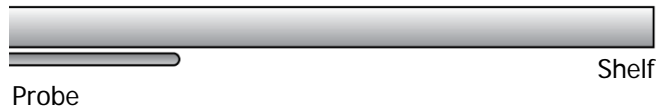
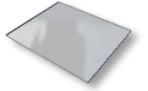

Install 4 Shelf Clips



Rocking Motion

Place the Shelf

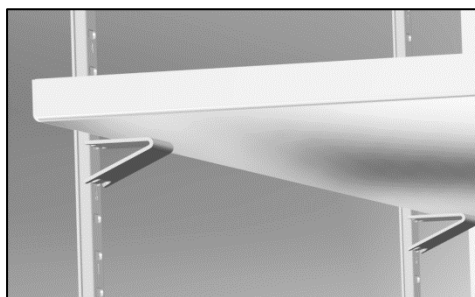

1. Install the shelf clips in the slots of the shelf standard mounting rails located on the sides of the chamber interior, 4 clips per shelf.
  - a. Squeeze each clip, insert the top tab first, and then the bottom tab using a rocking motion.
2. Set the shelves on the clips.
  - a. Verify the shelves are level.

# INSTALLATION

## CONNECT TO THE VACUUM SUPPLY

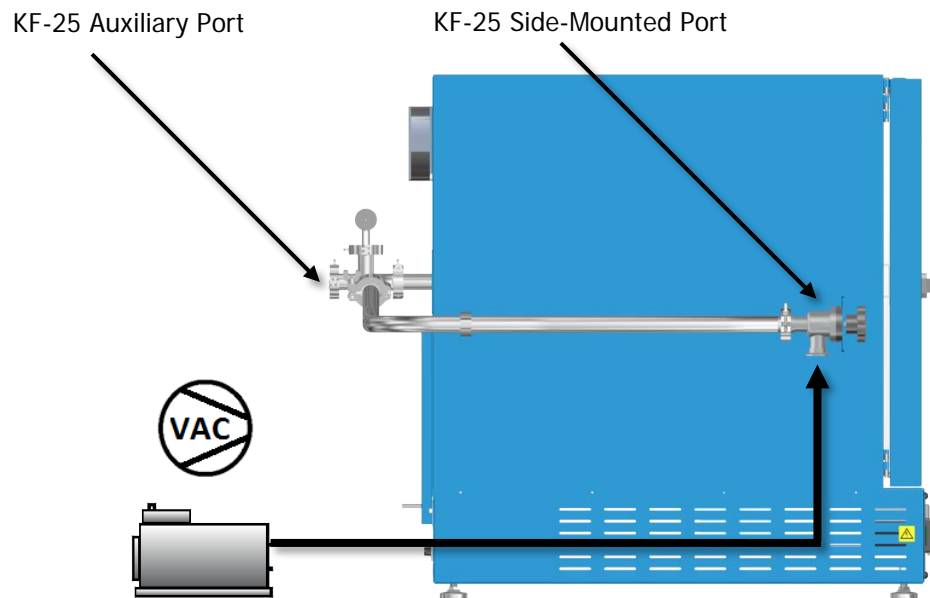

### 1. Connect the vacuum supply to the KF-25 Side-Mounted Vacuum Port

- **KF-25 Side-Mounted Vacuum Port**
  - Chamber atmosphere evacuates through this port. Connect the vacuum source to the oven here.
  - The port does **not** come with a KF-25 blank or clamp.
- **KF-25 Auxiliary Port**
  - Used for introducing sensor probes through a vacuum rated feedthrough.
  - The port comes with a KF-25 blank and clamp.

# INSTALLATION

## *CONNECT TO A GAS BACKFILL SUPPLY*

Optional

The maximum allowed gas backfill pressure is **15 psi** delivery at both ports.

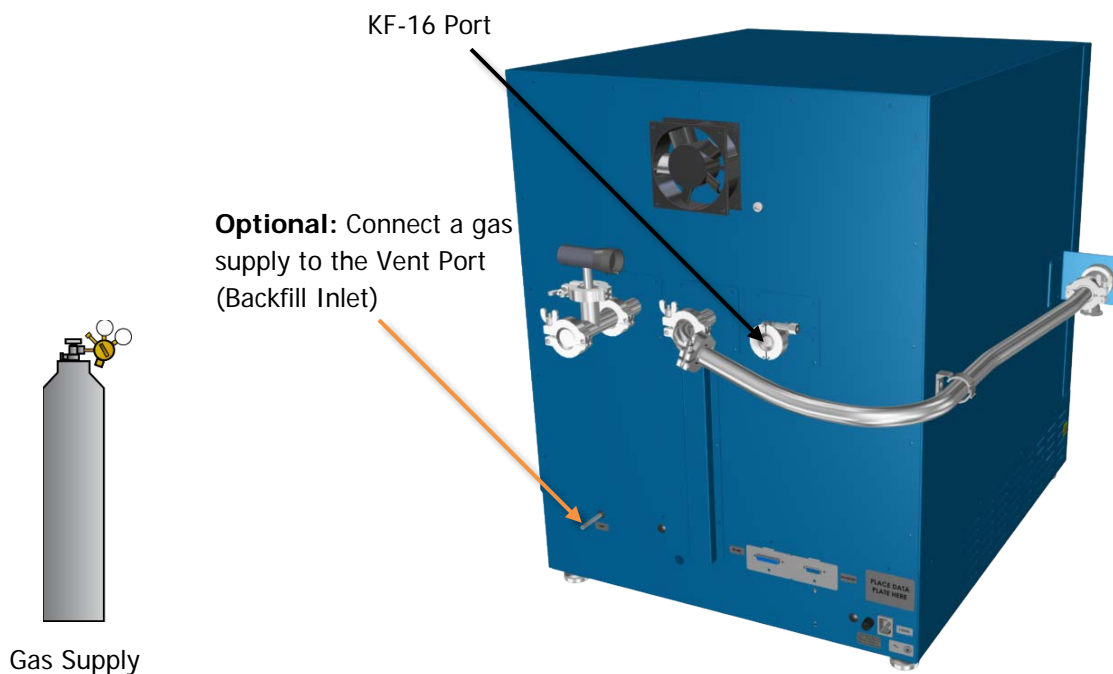

- **Vent Port (Backfill Inlet) – 1/4 Inch (6.35 mm) OD**







- External atmosphere backfills the oven chamber through this port when the Vent Valve control on the front control panel is opened.
- A clean or inert gas supply source may be connected to this port.

- **KF-16 Port**

- A clean or inert gas supply source may be connected to this port to facilitate rapid backfilling.
- Comes with a KF-16 blank and clamp.

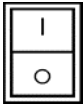
# GRAPHIC SYMBOLS

The oven is provided with multiple graphic symbols on its interior and exterior surfaces. The symbols identify hazards and the functions of the adjustable components, as well as important notes in the operation manual.

Symbol	Definition
	Consult the operation manual Consulter le manuel d'utilisation
	Over Temperature Limit system Thermostat température limite contrôle haute
	AC Power Repère le courant alternatif
	I/ON O/OFF I indique que l'interrupteur est en position marche. O indique que le commutateur est en position d'arrêt.
	Potential shock hazard Risque de choc électrique
	Recycle the unit. Do not dispose of in a landfill. Recycler l'unité. Ne jetez pas dans une décharge
	Protective earth ground Terre électrique

# CONTROL OVERVIEW

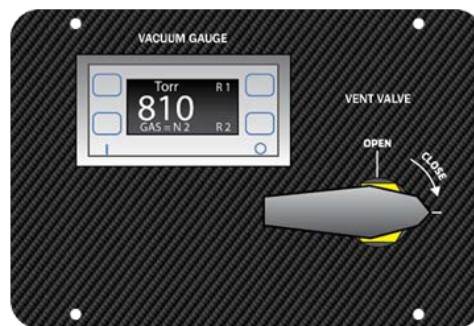
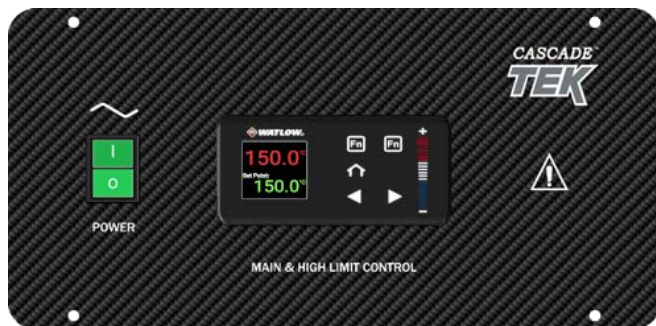

Control Panel

## Power Switch

The switch illuminates when in the ON ( I ) position.



## Temperature Controller - Display on Homepage

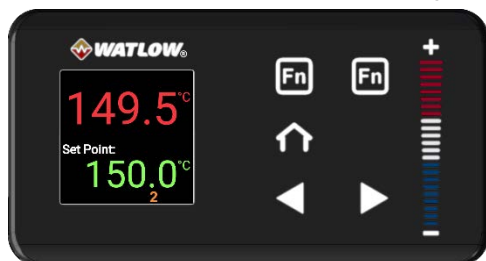

- Top Line (Red): Present chamber shelving temperature
- Middle Line (Green): The constant temperature setpoint
- Bottom Line: Flashing "2" indicates active heating.

The Home button allows immediate navigation back to the home screen, where it displays the current temperature and the set temperature.



While on the homepage, use the (+) and (-) buttons or swipe up or down on the +/- bar to alter the constant temperature setpoint. On Operations pages, these controls are used to select Operation options, modify the high limit setpoint, adjust calibration offsets, and configure program variables.



From the homepage, pressing the **forward arrow** button progresses through various parameter option pages, such as Event 1 and Units of Measurement (Celsius or Fahrenheit). This button is also used for advancing through menus and parameter lists while programming a temperature recipe.



The **back arrow** button takes the display back to the previous page or menu. Continuously pressing this button will eventually navigate the display back to the homepage.



Pressing the **left Fn** button activates Profile Program 1. Pressing it again during its execution will stop Program 1. Similarly, the **right Fn** button initiates Profile Program 2 (Step 11) and pressing the button a second time while it is running will halt Program 2



# CONTROLS

## Vacuum Gauge

~810 torr – Room atmosphere pressure for N<sub>2</sub> at or near sea level



Shows the chamber pressure level in torr and millitorr (mTorr). The gauge that this display connects to measures the pressure of pure nitrogen (N<sub>2</sub>) and is used to control the automated backfill function. Backfilling is commonly done using N<sub>2</sub> or other inert gases.



Open

## Vent Valve Control – Backfill Inlet

This valve opens and closes the chamber inlet Vent Port on the back of the oven.

- In the **open** position, the oven chamber is open to external atmosphere through the vent intake port on the back of the oven.
- Optional: An inert or clean backfilling gas supply connected to the Vent Port will flow gas from the pressurized supply to an evacuated oven chamber when the Vent Valve is open.
- In the **closed** position, the chamber is cut off from external atmosphere and any gas supply.
  - **The vent must be closed before applying vacuum to the chamber.** Failure to do so may result in damage to your vacuum pump.

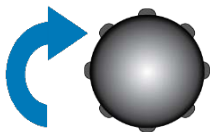

Close

## Vacuum Valve Control

This valve opens and closes the KF-25 Vacuum Port on the left side of the oven.

- In the **open** position, this valve allows the connected vacuum supply to evacuate the oven chamber.
- In the **closed** position, the valve cuts off the vacuum draw.

This valve should always be closed before a vacuum pump attached to the oven is turned off. This safeguards the pump from external atmosphere being drawn through it and into the oven. If an attached oil pump is turned off while the valve is open and the chamber is under vacuum, oil may be pulled out of the pump and into the oven.



Safe operation of the oven is dependent on the actions and behavior of the oven operators. Operating personnel must read and understand the Operating Precautions in this section prior to operating the oven. The operators must follow these instructions to prevent injuries and to safeguard their health, environment, and the materials being treated in the oven, as well as to prevent damage to the oven. Failure to adhere to the Operating Precautions, deliberately or through error, is a hazardous behavior on the part of the operator.



Le fonctionnement sûr du four dépend des actions et du comportement des opérateurs du four. Le personnel d'exploitation doit lire et comprendre les consignes de sécurité et les précautions d'utilisation de cette section avant d'utiliser le four. Les opérateurs doivent suivre ces instructions pour prévenir les blessures et protéger leur santé, leur environnement et les matériaux traités dans le four, ainsi que pour éviter d'endommager le four. Le non-respect des consignes de sécurité et des précautions d'utilisation, délibérément ou par erreur, est un comportement dangereux de la part de l'opérateur.

## *OPERATING PRECAUTIONS*

- Do not use this oven in unsafe improper applications that produce flammable or combustible gases, vapors, liquids, or fuel-air mixtures in quantities that can become potentially explosive.
- Outgassed byproducts may be hazardous to or noxious for operating personnel. Vacuum pump exhaust should be vented to a location outside the workspace in a safe manner in accordance with all applicable laws, ordinances, and regulations. Do not operate the oven in an unsafe area with noxious fumes.
- Do not use this oven for applications heating hazardous fibers or dust. These materials can become airborne and come into contact with hot surfaces.
- Individual ovens are not rated to be explosion proof. Follow all building certification requirements and laws for Class I, II, or III locations as defined by the US National Electric Code.
- The bottom surface of the chamber should not be used as a work surface. It runs hotter than the shelf temperatures. Never place samples or product on the oven chamber floor.
- Do not place sealed or filled containers in the oven. These may burst open when the chamber is under vacuum.
- Do not place alcohol or mercury thermometers in the oven. With improper use, they can rupture.
- Do not move the oven until it has finished cooling.



---

**Burn hazard:** Use proper personal protective equipment to minimize the risk of burns when the oven door is open and the chamber door interior, chamber surfaces, and shelving are hot.

**Risques de brûlure:** Utilisez un équipement de protection individuelle approprié pour minimiser le risque de brûlures lorsque la porte du four est ouverte et que l'intérieur de la porte de la chambre, les surfaces de la chambre et les étagères sont chauds.

---

# OPERATION

## *THEORY OF OPERATION*



### **Vacuum**

Vacuum is supplied by an external vacuum supply (a pump or building system) connected to the KF-25 vacuum port mounted on the left side of the oven. Vacuum levels obtained in the oven chamber are dependent on pump type and performance, valve settings, and the nature of the application or process, including the volume of outgassed materials.

The chamber atmospheric pressure is displayed on the Vacuum Gauge on the main control panel.

The chamber should be sealed and evacuated at the start of a vacuum baking application. The oven is not built to operate with the chamber exposed to atmosphere. Running the oven with the door or the vent open risks destroying the vacuum pump, damaging the integrity of the oven chamber, and may oxidize chamber surfaces.

Vacuum pumps and chamber liner gaskets should be selected on the basis of application type or process. Pumps vary in suitability and safety depending on the outgassed byproduct types and moisture level produced in the oven chamber. Gasket types are both resistant to and vulnerable to different chemicals.



### **Gas Backfill**

A gas or clean air supply can be connected to the vent port (backfill inlet) located on the back of the oven. Nitrogen or another inert gas are typically used to avoid particulate contamination or the oxidation of product that has not cooled down. The maximum allowed backfill pressure is 15 psi of delivery at the port.

The port valve is opened and closed using the Vent control on the front panel.



### **Heating Options**

The oven can either heat to and run at a constant temperature setpoint or execute a programmable multistep temperature recipe with ramp up, heat soak, and ramp down intervals.



## Heating in a Vacuum

In conventional ovens, powered elements transfer heat into the chamber air. The hot air then circulates by natural convection or blower fan action, surrounds the product on the shelves, gradually bringing it to temperature. In a vacuum oven, heat transfer occurs in part through direct infrared radiation. A significant portion, however, takes place through conduction. The oven heating elements located inside the chamber walls and floor transfer heat to the shelves via metal-on-metal contact. Each shelf then transports heat to the products or samples resting on it.

The displayed oven temperature may change when pumping down the oven. This reflects the chamber probe transitioning from measuring air temperature to shelf temperature, followed by a redistribution of thermal energy in the vacuum environment. This may present as a drop in temperature followed by an apparent rise. The drop may take place even if the oven is actively heating.

## Heating Control

The controller monitors the oven chamber shelving temperature using a thermocouple temperature probe extending into the chamber from the back wall. In a vacuum environment, the probe senses the temperature of the shelf placed immediately above it. Placement of a shelf in close proximity to – but not in contact with the probe — is crucial for accurate measurement of the shelving temperature in the vacuum chamber.

The unit uses Proportional – Integral – Derivative (PID) control to avoid significantly overshooting the setpoint. The rate of heating will slow as the chamber temperature approaches the target temperature. If the chamber temperature is above the setpoint, the unit uses minimum heating to control the rate of cooling and avoid dipping below the setpoint.

PID loops also optimize heating rates to compensate for the temperature environment around the unit. If the unit is operating in a cool room, the controller will increase the length of the heating pulses. Likewise, when operating in a warm room the unit uses shorter pulses. If the ambient temperature conditions change significantly, there may be minor over or undershoots as the unit adapts.

The oven relies on natural heat radiation for cooling. It can achieve a low-end operating temperature of the ambient room temperature plus the oven waste heat.



## High Limit Control System

The temperature controller contains a heating cutoff system with independent circuitry connected to a redundant solid-state temperature sensor probe inside the oven chamber. This high limit system depowers the oven heating elements whenever the chamber shelving temperature exceeds the current limit setting. This safeguards the oven in the event of a failure of the main temperature control circuitry or the main temperature sensor probe.

**The high limit is set by the operator** to a minimum of 10°C above the highest temperature of the application process the oven is currently being used for. Failure to set the high limit control system voids the oven manufacturing defect warranty in the event of an overtemperature event.

# OPERATION

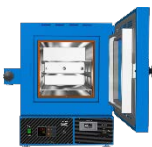

## PUT THE OVEN INTO OPERATION

Perform the procedures below after the unit has been installed in a new workplace location. These verify the integrity of the vacuum system and prepare the oven for normal use.

### 1. Attach the Power Cord



Attach the power cord that came with the unit to the power inlet receptacle on the back of the oven.

Plug the power cord into the workspace electrical supply.

### 2. Verify the Door and Valves are Closed

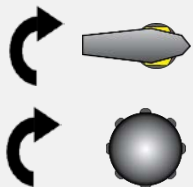

Verify the oven **chamber door** is **closed and latched**, and that the **vent intake valve and vacuum valve** are in the **closed position** (turned all the way clockwise).

- This safeguards your vacuum pump from exposure to streaming atmosphere.

### 3. Turn on the Oven



Place the oven **Power Switch** in the ON ( I ) position.

- The controller display will illuminate and default to its homepage.
- The vacuum display will illuminate.

### 4. Set the High Limit Temperature

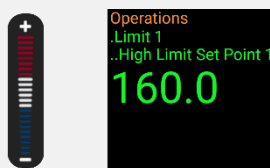

Use the [Set the High Temperature Limit](#) procedure on page 38 to set to the Limit heating cutoff at least 10°C above the highest intended temperature of your application.

### 5. Plug in the Vacuum Pump



Plug the vacuum pump power cord into a wall power source.

Continued next page

# OPERATION

Continued from the previous page



## 6. Verify Vacuum Integrity

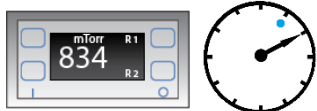

10 Minutes Minimum

Use the [Evacuating and Backfilling the Oven Chamber](#) procedure on page 39 to pump down and hold the oven chamber under vacuum for 10 minutes to verify the integrity of the vacuum supply system.

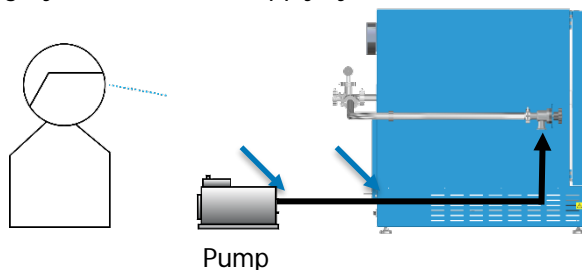

## 7. Setting the Operating Temperature

Read these procedures and descriptions.

- [Set the constant temperature setpoint.](#) See the procedure on page 40.

Or

- [Program multistep heating recipes.](#) See the description on page 40.

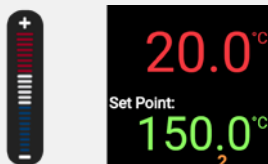

The oven is now ready for use



## SET THE HIGH TEMPERATURE LIMIT

**Note:** Test the high limit system once per year for functionality.

Set the high temperature limit at least 10°C above the highest temperature the oven will run at during your recipe program or constant-temperature application. See the High Temperature Limit system explanation on page 35.

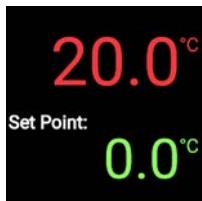

Goto  
Operations

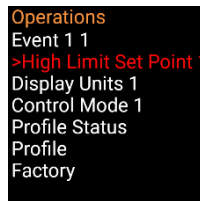

Select  
High Limit  
Set Point



Advance



Adjust value



Return Home



End of Procedure

# OPERATION

## EVACUATING AND BACKFILLING THE OVEN CHAMBER



Put the oven chamber under vacuum and hold for at least 10 minutes when first putting the oven into operation in a new location to verify the integrity of the vacuum supply system. The oven chamber must be drawn down to at least 500 torr in order to seal.

### Evacuate the Oven Chamber

#### 1. Verify the Vacuum and Vent Valve controls are in the closed position

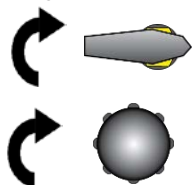

- This protects your vacuum pump from exposure to streaming atmosphere.

#### 2. Turn on your vacuum pump



#### 3. Open the oven Vacuum Valve

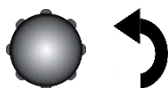

VACUUM

Turn the control all the way counterclockwise

- The Vacuum Gauge on the front panel should show the chamber pressure decreasing.
- The achievable vacuum level is dependent on altitude above sea level as well as the vacuum supply efficiency and the volume of outgassed byproducts.



### Hold Under Vacuum



Continue evacuating the chamber throughout the baking application to vent outgassed byproducts.

### Backfill the Oven Chamber

#### 4. Close the Vacuum Valve

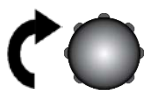

VACUUM

Turn the Vacuum Valve control back to the closed position (clockwise) to protect the vacuum pump from extended exposure to streaming atmosphere.

- The pump may remain on.

#### 5. Slowly open the Vent Valve



VENT

The chamber will return to room pressure.



End of Procedure

# OPERATION

## SETTING THE CONSTANT TEMPERATURE SETPOINT



### Adjust the constant temperature setpoint on the homepage

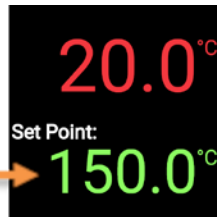
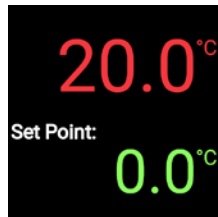

Stay 10°C below the high limit setpoint.

Press and hold the (+/-) buttons, or swipe up or down on the bar, to adjust the temperature setpoint.

### Saving new setpoint.

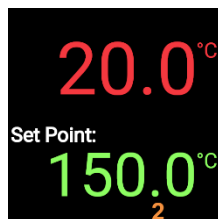

If there is no change in the setpoint for 3 seconds, the setpoint value will flash green and save the new setting.

## TEMPERATURE PROGRAMS



Please see the temperature program manual included with this oven for how to program automated heating recipes. The guide provides illustrated explanations for all major program functions and programming steps.

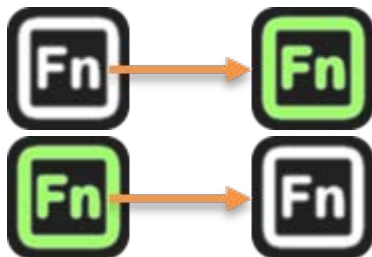

Pressing the **left FN** button activates heating Program 1, turning the button green to indicate it is in use. Pressing the button again during operation will terminate Program 1.

Pressing the **right FN** button activates heating Program 2 (Step 11), turning the button green to indicate it is in use. Pressing the button again during operation will terminate Program 2.



## HIGH TEMPERATURE LIMIT ACTIVATED

The High Limit system cuts off heating in the oven whenever the chamber temperature meets or exceeds the Limit setting. Heating remains disabled until the oven operator clears the Limit cutoff.

### Indicators

When heating is cut off, the oven display flashes two alternating alert screens. Additionally, an illuminated "4" on the bottom display level specifies that the oven should be routing electricity away from the heating elements.

### Possible Causes of High Limit Activation

- The oven temperature is set above or near the High Limit cutoff setting. The High Limit should be set at least 10°C above the highest intended temperature of your heating application.
- A heat source in the oven chamber is pushing the oven temperature above the limit setting.
- Significant outgassing in the chamber may be interfering with the measured temperature.
- Attempting to heat a significant mass of product or samples may trigger a temperature overshoot and subsequent Limit cutoff.
- The oven temperature controller circuitry or sensor probe has failed.

If you suspect an ignition event in the oven chamber or a hardware failure **wait for the oven to cool to room temperature before opening the chamber door.** Contact [Customer Support](#) for assistance.

### Clearing the High Limit Heating Cutoff

- Clearing the cutoff restores power to the oven heating elements.
- The oven chamber temperature must be below the High Limit cutoff setting before clearing the cutoff.
- Always verify it is safe to resume heating before clearing the High Limit cutoff.

If the oven temperature falls to at least 2°C below the High Limit Setting, pressing the Home button will enable heat and turn off the alert.

### Alternating Alert Screens



### Attention Screen

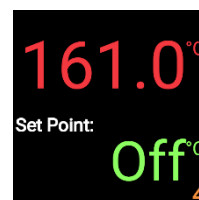

### Heating Off



## CHANGING THE UNIT OF MEASUREMENT

The controller can display temperatures in either Celsius or Fahrenheit.



Goto  
Operations

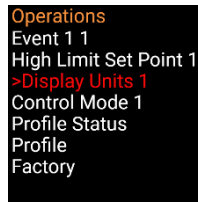

Select  
Display Units 1



Advance



Adjust value



Return Home



°C → °F

## *DATA PORTS*



### **25-Pin Port**

The 25-pin RS485 data port, located on the back of the oven, connects to the oven temperature controller. The port is primarily intended for updating the controller software but can be used for data logging and graphical temperature recipe programming. Accessing the controller with a computer requires a 25-pin RS485-to-USB converter cable and driver software.

### **Applications and Utility Software**

- **National Instrument LabView** and **Watlow SpecView** — Temperature monitoring and data logging in graphical user interface environments.
- **Watlow's Composer** — Programming temperature recipes in a drop-down menu environment. Configurator can also be used to copy and save the controller configuration file, which includes the currently programmed heating programs.
  - Configurator is available for free on the Watlow website.



### **9-Pin Port**

This port connects with accessories ordered from the oven manufacturer, including dataloggers.

## *OVEN COOLDOWNS*

The oven chamber is well insulated and requires a significant amount of time to cool down while sealed and evacuated. Please see the Unit Specifications chapter for cooldown times.

- Introducing free atmosphere into the oven when the chamber temperature is above 100°C risks oxidizing chamber surfaces.
- Backfilling the oven with N<sub>2</sub> does not significantly increase the rate of cooling.

# OPERATOR MAINTENANCE



---

**Warning:** Disconnect the unit from its power supply prior to maintenance or cleaning of this unit.

**Avertissement:** Avant d'effectuer toute maintenance ou entretien de cet appareil, débrancher le cordon secteur de la source d'alimentation.

---

## *CLEANING*

If a hazardous material or substance has spilled in the unit, immediately initiate your site Hazardous Material Spill Containment protocol. Contact your local Site Safety Officer and follow instructions per the site policy and procedures.

- Do not use spray-on cleaners or disinfectants. These can leak through openings and coat electrical components.
- Do not use cleaners or disinfectants that contain solvents capable of harming paint coatings or stainless steel surfaces. **Do not use chlorine-based bleaches or abrasives, these will damage the chamber liner.**
- Consult with the manufacturer or their agent if you have any doubts about the compatibility of decontamination or cleaning agents with the parts of the equipment or with material contained in it.



---

**Warning:** Exercise caution if cleaning the unit with alcohol or flammable cleaners. Always allow the unit to cool down to room temperature prior to cleaning and make sure all cleaning agents have evaporated or otherwise been completely removed prior to putting the unit back into service.

**Avertissement:** Soyez prudent lorsque vous nettoyez l'appareil avec de l'alcool ou des produits de nettoyage inflammables. Laissez toujours refroidir l'appareil à la température ambiante avant le nettoyage et assurez-vous que tous les produits de nettoyage se sont évaporés ou ont été complètement enlevés avant de remettre l'appareil en service.

---

## **Oven Chamber Cleaning Guidelines**

1. Disconnect the unit from its power supply.
2. Remove any removable chamber accessory items such as shelving if present.
3. Use 99% isopropyl alcohol to clean chamber surfaces and shelving. Apply using lint-free wipes.
4. Take special care when cleaning around temperature sensor probes. Do not clean the probes.
5. Clean all removable accessories and components.
6. Verify the cleaning alcohol has evaporated completely from all chamber surfaces and accessories prior to reconnecting the unit to its power source.

## Oven Exterior Cleaning Guidelines

1. Disconnect the unit from its power supply.
2. The manufacturer recommends cleaning the unit with a mild soap and water solution.
  - **Do not use abrasive cleaners**, these will damage metal surfaces.
  - Cleaning agents must be compatible with steel and powder coat paint surfaces.
  - Do not use deionized water to rinse or clean with.
3. Rinse with distilled water and wipe dry with a soft cloth.

## *MAINTAINING ATMOSPHERIC INTEGRITY*

Periodically, inspect the door latch, trim, catch, and gasket for signs of deterioration. Failure to maintain the integrity of the door system shortens the lifespan of the unit.

The gasket should be replaced if it is dry, cracked, or otherwise showing a loss of elasticity.

## *ELECTRICAL COMPONENTS*

Electrical components do not require maintenance. If the oven fails to operate as specified, please contact your distributor or [Customer Support](#) for assistance.

## *VACUUM PUMP MAINTENANCE*

Refer to the operation manual supplied with your vacuum pump for recommended maintenance routine, such as oil levels, replacement of sorbent charge, and exhaust filter change-outs. **Contact your vacuum pump supplier if you do not have an operation manual.**

## *STORAGE*

To prepare the unit for storage, remove all shelves, dry the chamber completely, and disconnect the power supply. Be certain that the door is positively locked in the closed position.

# MAINTENANCE

## HEATING ISSUES — DIAGNOSTIC QUESTIONNAIRE

If the unit is experiencing heating issues, use this questionnaire to gather information on the unit prior to contacting Customer Support. Gathering and sharing this information aids Customer Support in making timely and accurate remote diagnoses. Additionally, datalogger files as well as pictures and videos of the unit in its failure mode are valuable diagnostic resources that can be shared with Customer Support.

### Overview

You will be performing the following tasks to gather onsite data:

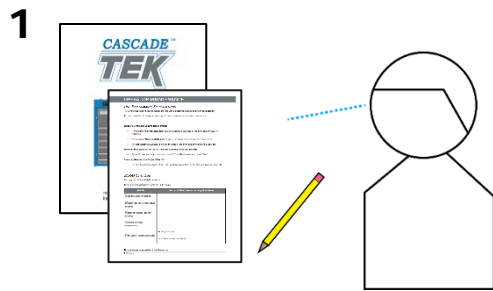

1 Verify the Unit Conditions using the procedure on page 47.

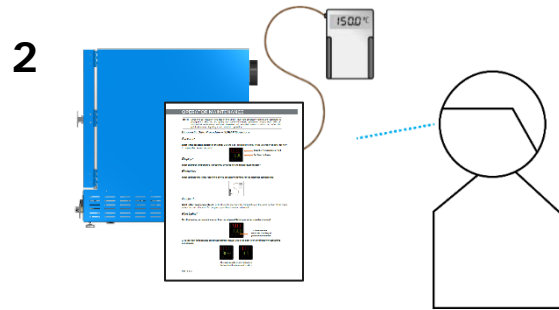

2 Read the Preparing topic on page 48, then observe the unit in operation using the Heating Diagnostic questions on page 49.

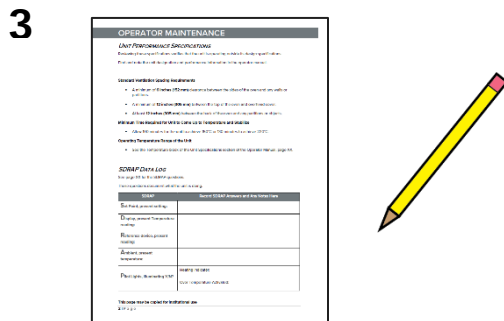

3 Record your observations in the Heating Diagnostic Data Log on page 50.

4 **Share the gathered information with Customer**

### Unit Model Information

Find the unit data plate (see page 12) and record the information on it below. This information is critical for accurate diagnoses as displays, gauges, valves, and port types vary based on the unit model and customization options.

<b>MODEL NO:</b>	
<b>SERIAL NO:</b>	
<b>PART NO:</b>	
<b>PART ID:</b>	

# MAINTENANCE

**Note:** Does the car actually have gas in the tank? Have you physically verified the computer is plugged in? Yes, we are going to ask some very basic questions. Please bear with us. Methodical verifications and the elimination of potential failure causes are often the quickest means of getting a unit back into operation.

## Verify the Unit Conditions

Verify the following items to make sure the unit is actually malfunctioning.

Condition Checks	Condition Data Location	Record Results Here
<b>Ambient Conditions:</b> Verify the room temperature falls within the required range.	See the <b>Required Ambient Conditions</b> topic on <b>page 19</b> . Operating the unit outside the specified room temperature range will adversely impact its temperature performance	The room temperature falls within the required range: <b>Yes or No?</b>
<b>Spacing Clearances:</b> Verify there is enough ventilation spacing around the unit.	See the <b>Required Clearances</b> topic on <b>page 19</b> . Insufficient ventilation spacing may adversely impact temperature performance.	The oven has the minimum required clearance spacing around it: <b>Yes or No?</b>
<b>Operating Range:</b> Verify the oven is designed to achieve the temperature you are attempting to run it at.	See the unit <b>Temperature Specs</b> on <b>page 58</b> . The oven will not operate outside the <b>Range</b> specification.	Are you attempting to operate the oven within the specified range: <b>Yes or No?</b>
<b>Heat-up Time:</b> Verify the oven has enough time to come up to temperature.	See the unit <b>Temperature Specs</b> on <b>page 58</b> . The oven will not heat up faster than the given <b>Time to Temperature</b> specifications.	The oven is being allowed sufficient time to come up to temperature: <b>Yes or No?</b>
<b>Stability and Uniformity:</b> Verify the unit is rated to provide the stability and uniformity you are attempting to achieve.	See the unit <b>Temperature Specs</b> on <b>page 58</b> . The oven will not reliably achieve a better performance than the stated <b>Uniformity and Stability</b> specifications. *	You are attempting to achieve uniformity and / or stability matching the stated specifications: <b>Yes or No?</b>

\* The oven may require time to achieve the specified temperature stability and uniformity after heating up to or cooling down to an operating setpoint. This is affected by the ambient conditions around the oven, the mass of the product or samples in the oven chamber, as well as the volume of outgassing taking place. The longer the oven has been operating, the more heat soaked it is. This generally shortens the time for the temperature to stabilize.

# MAINTENANCE

**Optional: Obtain a temperature reference device.** A calibrated digital thermometer with a vacuum-rated thermocouple feedthrough. The device must be accurate to at least 0.1°C.

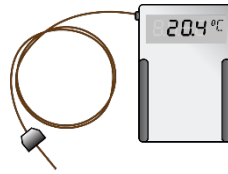

## Preparing for the Heating Diagnostic Observations

**1.** The unit must be connected to a power source that meets the requirements in the Installation chapter (page 20) and turned on.



**2.** Optional: secure the reference temperature device sensor probe at the center of the bottom shelf, with the probe head in direct contact with the shelf surface.

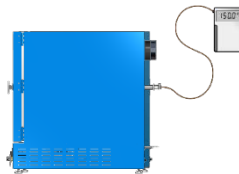

**3.** The oven chamber must be **empty, sealed** and be **under vacuum**. See the [Evacuating and Backfilling the Oven Chamber](#) topic on page 39.



**4.** The unit must have adequate time to come up to temperature and stabilize. **Failure to wait will result in an inaccurate diagnosis.**



- See the oven Time to Temperature specifications on page 58.
- Start the Heating Diagnostic Procedure **when the allotted time has passed**, even if the unit fails to achieve the setpoint temperature.

# MAINTENANCE

## Heating Diagnostic Questions

Record the answers in the log on page 50.

Setpoint?

What is the current temperature setpoint?



Chamber Temperature in Red  
Setpoint in Green

Chamber Temperature?

What temperature is presently showing on the temperature controller display?

Reference?

Optional: What temperature is the reference device presently showing for the chamber?

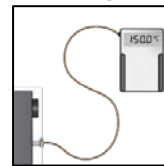

Heating Indicator On?

Is the heating active indicator on the temperature controller display flashing or otherwise illuminating, Y/N?



"2" indicates the controller is calling for power to the element

High Limit Activated?

Has the High Limit cutoff activated, Y/N?

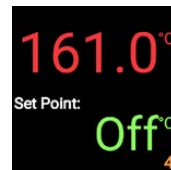

"4" indicates the controller is routing power away from the element

Alternating alert screens flash when the high limit heating cutoff is active.

Ambient?

What is the current room temperature? For best results, measure the temperature in the same section of the room where the unit is located. Do not place your thermometer on the unit.

## Heating Diagnostic Data Log

Record answers to the Heating Diagnostic questions in this log. These document the unit behavior.

Diagnostic Questions	Record Answers and Any Notes Here
<b>S</b> etpoint, present setting:	
<b>C</b> hamber Temperature, present reading:	
<b>R</b> eference Device, present reading:	
<b>H</b> eating Indicator On, Y/N?	
<b>H</b> igh Limit Activated, Y/N?	
<b>A</b> mbient, present temperature:	

### Other valuable diagnostic resources to share:

- Datalogger data
- Pictures and video of the unit in failure mode
- How long has the temperature issue been occurring?

## Share!

Share the Heating Diagnostic Data Log and Unit Specifications data with Customer Support. This data is crucial for offsite personnel making accurate remote diagnoses and is used to help ensure Customer Support can resolve the issue.

### Facilities Technicians

The Heating Diagnostic Data Log and Unit Specifications data are also useful to any institutional repair technicians at your facility who may be responsible for servicing of out-of-warranty units.

**This page may be copied for institutional use**

**End Diagnostic Data Procedure**

# MAINTENANCE

## Vacuum Leak Issues – DIAGNOSTIC QUESTIONNAIRE

If the unit is experiencing vacuum leak issues, use this questionnaire to gather information on the unit prior to contacting Customer Support. Gathering and sharing this information aids Customer Support in making timely and accurate remote diagnoses. Additionally, datalogger files as well as pictures and videos of the unit in its failure mode are valuable diagnostic resources that can be shared with Customer Support.

### Overview

You will be performing the following tasks to gather onsite data:

1

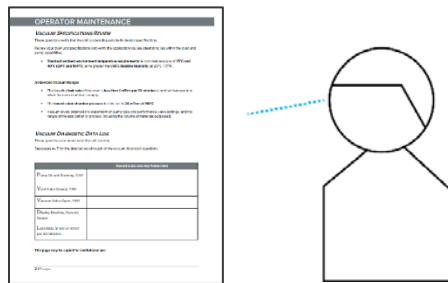

Verify the Unit Vacuum Conditions using the procedure on page 52.

2

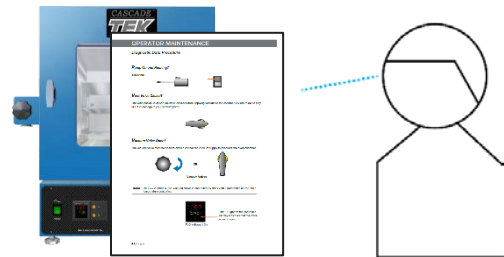

Read the Vacuum Diagnostic Setup topic on page 53, then observe the unit in operation using the Vacuum Diagnostic questions on page 54.

3

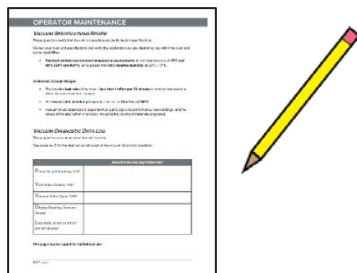

Record your observations in the Vacuum Leak Diagnostic Data Log on Page 56.

4

Share the gathered information with Customer

### Unit Information

Find the unit data plate (see page 12) and record the information on it below. This information is critical for accurate diagnoses as displays, gauges, valves, and port types vary based on the unit model and customization options.

MODEL NO:	
SERIAL NO:	
PART NO:	
PART ID:	

---

**Note:** Does the car actually have gas in the tank? Have you physically verified the computer is plugged in? Yes, we are going to ask some very basic questions. Please bear with us. Methodical verifications and the elimination of potential causes of failure are often the quickest means of getting a unit back into operation.

---

## Unit Vacuum Conditions

Verify the items below to ensure a fault in the oven rather than the pump or external vacuum plumbing or contamination is preventing the unit from achieving its specified performance levels. During normal operations, the oven can be vacuumed down to 500 torr to 10 mTorr depending on the performance of the pump, the oven chamber temperature, and the volume of outgassed byproducts. For most applications, the vacuum pump must remain on and connected to the oven chamber to remove outgassed byproducts.

- Is the chamber being **quickly** pumped down to 500 torr or lower? **Yes** or **No?**
  - The door will not seal completely at pressures higher than 500 torr.
  - A slow evacuation may not be sufficient to seal the door.
  - The vacuum pump must be rated to a minimum flow capacity of 1 cubic foot per minute (cfm) per cubic foot of chamber volume. Example: a 2 cubic-foot chamber should be connected to a pump that can evacuate at least 2 cubic feet per minute.
- Is the vacuum pump type suitable for your application or process? **Yes** or **No?**
  - The vacuum pump must be resistant to byproducts outgassed during the baking process. Otherwise, the integrity of the pump can be quickly compromised.
- Is the gasket type suitable for the application? **Yes** or **No?**
  - Each gasket type is resistant to and vulnerable to different outgassed byproducts. A gasket that is vulnerable to byproducts from your applications may fail after only a short period of use.
  - See page 60 of the user manual to verify that the installed gasket is suitable for your application.
- Is the oven chamber clean prior to being pumped down? **Yes** or **No?**
  - Outgassing from contaminants can cause a rise in chamber pressure. At very low pressure levels, the oven may register outgassing from fingerprints.
- Is the chamber being evacuated for the full duration of your baking application? **Yes** or **No?**
  - If the vacuum valve is closed during the baking application — isolating the chamber from the vacuum pump — outgassing from samples or products will raise the chamber pressure.

## Vacuum Diagnostic Setup

**1. Check the primary chamber gasket for damage.** This is the gasket mounted on the chamber liner that seals the oven chamber when the door is closed.

Look for:

- Cuts or nicks on the gasket caused by removing shelves or samples from the chamber.
- Cracking, brittleness, or loss of elasticity.
- Discoloration of the gasket.
- Nicks or other damage on the surface the gasket seals against.



**2.** The unit must be connected to a power source that meets the requirements in the Installation chapter (page 20) and turned on.

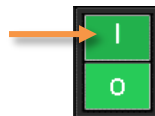
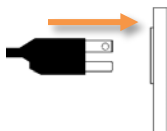

**3. Do not heat the oven.** The oven must remain at ambient temperature for this procedure.

**4.** The oven chamber must be **empty, sealed, clean,** and **under full vacuum draw.** See the [Evacuating and Backfilling the Oven Chamber](#) topic on page 39.

- Reminder: Outgassing products, samples, or contaminants such as fingerprints or spilled solvents will generate pressure and prevent the accurate diagnosis of a leak.



**Vacuum Gauge**

# MAINTENANCE

## Vacuum Diagnostic Questions

Record the answers in the log on page 56.

### Pump On and Running?

Yes or no?

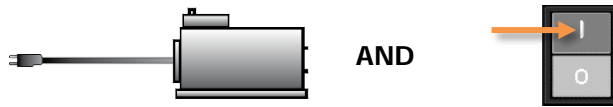

### Vent Valve Closed?

The vent (backfill inlet port) must be closed before applying vacuum to the chamber. Failure to do so may result in damage to your vacuum pump.

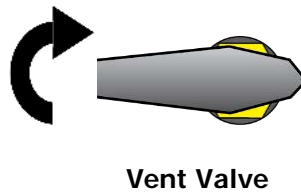

### Vacuum Valve Open?

The vacuum valve must be open to allow a connected vacuum supply to evacuate the oven chamber.

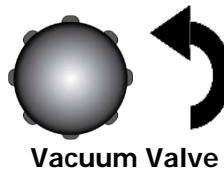

### Display Reading?

Record the chamber pressure level showing on the Vacuum Gauge display.



# MAINTENANCE

## Leak Rate?

### Calculate and record the leak rate of the evacuated and isolated oven chamber:

1. Verify the oven chamber and shelving are at room temperature (20 – 25°C).
2. Verify the oven chamber is clean and dry to prevent outgassing from contaminants or water.
3. Close the chamber door, then open the vacuum valve.
4. Allow the oven to vacuum down to the lowest vacuum level your pump can achieve.
5. Write down the pressure displayed on the Vacuum Gauge as a positive number.
  - This is Record 1.



6. Isolate the chamber by closing the vacuum valve.

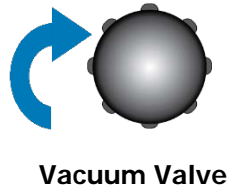

7. Allow the oven to sit sealed and undisturbed for 30 minutes.
8. Write down the pressure displayed on the Vacuum Gauge.

- This is Record 2.

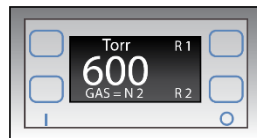

9. Subtract Record 1 from Record 2.

- Record 2 (torr) – Record 1 (torr) = the leak rate in torr per 30 minutes.

### Leak Criteria

The oven chamber may be leaking if the chamber pressure rises by **more than 30 mTorr during the 30 minute test** described above. **Note:** A significant increase during the first minute of testing is not uncommon. This is acceptable as long as the cumulative increase does not exceed the 30 mTorr in 30 minutes maximum.

## Vacuum Leak Diagnostic Data Log

Record the diagnostic question answers in this log. These questions document the unit behavior.

Diagnostic Questions	Record Answers and Any Notes Here
<b>P</b> ump On and Running, Y/N?	
<b>V</b> ent Valve Closed, Y/N?	
<b>V</b> acuum Valve Open, Y/N?	
<b>D</b> isplay Reading, Vacuum Gauge:	
<b>L</b> eak Rate, in torr or mTorr per 30 minutes:	

### Other valuable diagnostic resources:

- Datalogger files
- Pictures and video of the unit in failure mode
- How long has the vacuum issue been occurring?

## Share!

Share the Vacuum Leak Diagnostic Data Log and Unit Specifications data with customer Support. This data is crucial for offsite personnel making accurate remote diagnoses and is used to help ensure Customer Support can resolve the issue.

### Facilities Technicians

The Vacuum Leak Diagnostic Data Log and Unit Specifications data are also useful to any institutional repair technicians at your facility who may be responsible for servicing out-of-warranty units.

**This page may be copied for institutional use**

# UNIT SPECIFICATIONS

Please refer to the oven data plate for individual electrical specifications.

Technical data specified applies to units with standard equipment at an ambient temperature of 25°C and at nominal voltage. The temperatures specified are determined in accordance to factory standard following DIN 12880 respecting the recommended wall clearances of 10% of the height, width, and depth of the inner chamber. All indications are average values, typical for units produced in the series. We reserve the right to alter technical specifications at all times.

## WEIGHT

Model	Shipping Weight	Unit Weight
TVO-2-SVs	224 lb / 102 kg	183.0 lb / 83.0 kg
TVO-5-SVs	460 lb / 209 kg	365.0 lb / 166.0 kg

## DIMENSIONS

Inches

Model	Exterior W × D × H	Interior W × D × H
TVO-2-SVs	24.5 x 34.9 x 27.1 in	12.0 x 20.0 x 12.0 in
TVO-5-SVs	31.1 x 38.6 x 33.2 in	18.1 x 24.1 x 18.1 in

Millimeters

Model	Exterior W × D × H	Interior W × D × H
TVO-2-SVs	623 x 886 x 689 mm	304 x 508 x 304 mm
TVO-5-SVs	790 x 981 x 844 mm	459 x 612 x 459 mm

## CAPACITY

Model	Cubic Feet	Liters
TVO-2-SVs	1.67	47.2
TVO-5-SVs	4.50	127.4

## SHELF CAPACITY BY WEIGHT

Model	Per Shelf	Maximum Total Load	Max. No. Shelves
TVO-2-SVs	35.0 lb / 15.8 kg*	105.0 lb / 47.6 kg**	3 Shelves
TVO-5-SVs	35.0 lb / 15.8 kg*	105.0 lb / 47.6 kg**	6 Shelves

\*35.0 lb / 15.8 kg with weight evenly distributed across the shelf.

\*\*105.0 lb / 47.6 kg total load in the chamber. Exceeding this limit risks damaging the chamber liner.

# SPECIFICATIONS

## VACUUM

All Ovens

### Operational Vacuum Range

torr	mbar
720 to 10 mTorr @ Ambient*	910.5 to <0.0319 @ Ambient*

\*Pump dependent.

### Vacuum Display Range

torr	mbar
1100 to 0.1 mTorr	1466 to 0.001

### Leak Rate

30 mTorr per 30 minutes @ Ambient
-----------------------------------

## TEMPERATURE

### Range, Stability, and Uniformity

Model	Range	Stability	Uniformity
TVO-2-SVs	Ambient +10° to 220°C	± 0.2°C @ 150°C	±6% of Setpoint
TVO-5-SVs	Ambient +10° to 220°C	± 0.25°C @ 150°C	±6% of Setpoint

The maximum temperature is dependent on the type of chamber liner gasket installed. The oven comes with a silicone gasket installed that is rated to 230°C. See page 60 for the temperature ranges of other gasket types.

**Time to Temperature:** From an ambient temperature of +20°C.

Model	Heat Up to 80°C	Heat Up to 150°C	Heat Up to 220°C
TVO-2-SVs	70 Minutes	120 Minutes	175 Minutes
TVO-5-SVs	70 Minutes	120 Minutes	175 Minutes



## POWER

Model	AC Voltage	Amperage	Frequency
TVO-2-SV	110 – 120	10.0*	50/60 Hz
TVO-5-SV	110 – 120	13.0*	50/60 Hz
TVO-2-2-SV	220 – 240	5.5*	50/60 Hz
TVO-5-2-SV	220 – 240	7.0*	50/60 Hz

\*Use a dedicated 15-20 amp circuit.

# PARTS LIST

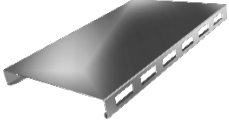
See the next page for gaskets

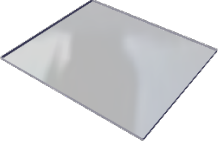
Description	Parts Number	Description	Parts Number
Adjustable Leveling Feet	 <b>2700506</b>	Power Cord, <b>TVO-2-2-SV</b> and <b>TVO-5-2-SV</b> 250 volt, 10 Amp, 8ft 2in (2.5m), CEE 7/7	 <b>1800500</b>
Fuse, <b>TVO-2-SV</b> and <b>TVO-5-SV</b> T16A 250V 5x20mm	 <b>3300513</b>	Short Shelf, TVO-2-SVs	 <b>9751342</b>
Fuse, <b>TVO-2-2-SV</b> T6.3A 250V 5x20mm (Requires 2)	 <b>3300515</b>	Tall Shelf, TVO-2-SVs	 <b>5680588</b>
Fuse, <b>TVO-5-2-SV</b> T10A 250V 5x20mm (Requires 2)	 <b>3300516</b>	Shelf Clip, Individual (1), TVO-5-SVs	 <b>1250510</b>
Power Cord, <b>TVO-2-SV</b> and <b>TVO-5-SV</b> 125 volt, 15 Amp, 9ft 5in (2.86m) NEMA 5- 15P	 <b>1800510</b>	Shelf, TVO-5-SVs	 <b>5680563</b>
Power Cord, <b>TVO-2-2-SV</b> and <b>TVO-5-2-SV</b> 240 volt, 15 Amp, 8ft 2in (2.5m) NEMA 6-15P	 <b>1800539</b>		

## REPLACEMENT GASKETS

Available Gasket Types	Part Number
<p><b>Silicone</b>, black or red, (comes with oven), rated to 230°C</p> <p><b>Applications:</b> General and high temperature</p> <p><b>Resistant to:</b> Moderate or oxidizing chemicals, ozone, and concentrated sodium hydroxide</p> <p><b>Attacked by:</b> Many solvents, oils, concentrated acids, and diluted sodium hydroxide</p>	<p><b>TVO-2-SVs:</b> 9490542</p> <p><b>TVO-5-SVs:</b> 9490544</p>
<p><b>Buna-N</b> rated to 125°C</p> <p><b>Applications:</b> Solvent</p> <p><b>Resistant to:</b> Many hydrocarbons, fats, oils, greases, and hydraulic fluids.</p> <p><b>Attacked by:</b> Ozone, ketones, esters, aldehydes, chlorinated and nitro hydrocarbons.</p>	<p><b>TVO-2-SVs:</b> 3450708</p> <p><b>TVO-5-SVs:</b> 3450724</p>
<p><b>Fluorosilicone</b> rated to 175°C</p> <p><b>Applications:</b> Acidic</p> <p><b>Resistant to:</b> Moderate or oxidizing chemicals, ozone, aromatic chlorinated solvents, and bases.</p> <p><b>Attacked by:</b> Brake fluids, hydrazine, and ketones.</p>	<p><b>TVO-2-SVs:</b> 3450611</p> <p><b>TVO-5-SVs:</b> 3450612</p>
<p><b>Viton®</b> rated to 205°C</p> <p><b>Applications:</b> Acidic</p> <p><b>Resistant to:</b> All aliphatic, aromatic and halogenated hydrocarbons, acids, and animal and vegetable oils.</p> <p><b>Attacked by:</b> Ketones, low molecular weight esters, and compounds containing nitro.</p>	<p><b>TVO-2-SVs:</b> 3450670</p> <p><b>TVO-5-SVs:</b> 3450671</p>
<p><b>Gasket Dimensions</b></p> <p><b>TVO-2-SVs</b> – 12 x 12 Inches      (305 x 304 mm)</p> <p><b>TVO-5-SVs</b> – 18 x 18 Inches      (458 x 458 mm)</p>	

### Ordering Parts and Consumables

Parts may be ordered from Cascade TEK by calling 1-800-322-4897. Please have the **model**, **part**, and **serial** numbers and **Part ID** of the unit ready, as Customer Support will need this information to match your unit to its correct part.

# CASCADE™

---

# TEK

**SHELDON**  
MANUFACTURING.INC

Cascade TEK  
by Sheldon Manufacturing, Inc.  
300 N. 26<sup>th</sup> Ave.  
Cornelius, OR 97113  
USA

support@cascadetek.com  
cascadetek.com  
1-800-322-4897  
503—640-3000